

A scenic landscape of rolling hills and mountains at sunset. The foreground shows a hillside with a house and a row of tall cypress trees. The middle ground features rolling hills with fields and a winding road. The background shows distant mountains under a hazy sky. The text "VINCENT SHEPPARD" is overlaid in the upper center.

VINCENT SHEPPARD

Outdoor collection
2026 - 2027

Finding comfort

Vincent Sheppard has been designing and manufacturing indoor and outdoor furniture with exceptional seating comfort since 1992. The company is worldwide market leader in Lloyd Loom furniture, a technique where kraft paper is twisted around a metal wire and woven into unique furniture pieces.

By constantly challenging itself and its design aesthetics, Vincent Sheppard is able to present young, contemporary furniture collections that answer to all modern needs. We combine a clear focus on quality and comfort with craftsmanship and an age-old technique, and translate these ingredients into qualitative, durable and appealing designs. With a wide variety of indoor as well as outdoor pieces of high quality, Vincent Sheppard is a favourite of many interior aficionados.

The Vincent Sheppard team

Index

COLLECTIONS

AKARI	34	MIA	187
ANTON	59	MISTRAL	4
BISTRO TABLES	92	MONA	122
CLEO	132	MORA	164
DAMIEN	148	NOA	122
DAVID	114	NOMAD	168
EDGARD	148	ODA	42
ELKO	18	OLAF	201
FIKA	18	OTTO	201
FLORENCE	172	OUTDOOR LLOYD LOOM	188
FREYA	122	REMI	122
FRIDA	52	RIBBON	4
INDIRA	166	ROY	86
IVO	176	ROXANNE	88
KENZO	186	ROZY	176
KODO	60	SAFI	178
LENA	148	SAM	122
LENTO	78	SANDRO	34
LEO	140	SAYA	170
LIGHT MY TABLE	152	SWEEP	4
LILO	104	TESSA	168
LOOP	104	TIKA	160
LUCY	94	TOMUS	14
MATTEO	148	VOLTA	122
MAYA	159	WICKED	24
MAX	138		

CUSHIONS & FABRICS	199
--------------------	-----

PRODUCT OVERVIEW	207
------------------	-----

MISTRAL RIBBON SWEEP

Sculptural elegance and easy comfort to the outdoors.

The Mistral dining table pairs a hand-finished white cement top, delicately speckled by embedded stones, with a sturdy central base for a welcoming, tactile presence.

Ribbon and Sweep feature a light, transparent profile: a durable aluminium frame and soft, handwoven rope seat, a supportive rounded back, and a weather-resistant, stackable design. Minimalist lines blend effortlessly into any setting. Designed by Studio Segers.

DINING CHAIR - LOUNGE CHAIR - FOOTREST - DINING TABLE





SWEEP DINING CHAIR rust | cinnamon
MISTRAL DINING TABLE salt white





RIBBON LOUNGE CHAIR AND FOOTREST moss | dark green
TESSA RUG sand



RIBBON DINING CHAIR taupe | sand
SANDRO DINING TABLE dune white | ceramic portland



RIBBON LOUNGE CHAIR taupe | sand
LILO SIDE TABLE rust
TESSA ROUND RUG sand



SWEEP DINING CHAIR

MATERIALS

polypropylene rope
powder coated aluminium

CUSHIONS

seat 2 cm quick dry foam

COLOURS

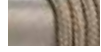

TAUPE SAND



RUST CINNAMON

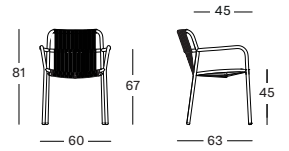

RIBBON DINING CHAIR

MATERIALS

flat polypropylene rope
powder coated aluminium

CUSHIONS

seat 2 cm quick dry foam

COLOURS



TAUPE SAND



MOSS DARK GREEN

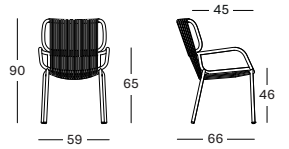

RIBBON LOUNGE CHAIR

MATERIALS

flat polypropylene rope
powder coated aluminium

CUSHIONS

seat 2 cm quick dry foam

COLOURS

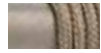

TAUPE SAND



MOSS DARK GREEN

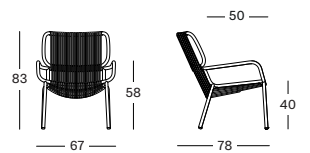

RIBBON FOOTREST

MATERIALS

flat polypropylene rope
powder coated aluminium

COLOURS

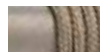

TAUPE SAND



MOSS DARK GREEN

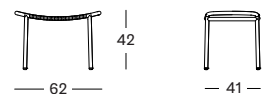



MISTRAL DINING TABLE

MATERIALS

speckled cement

DIMENSIONS

75 cm H x Ø 130 cm

75 cm H x Ø 150 cm

COLOURS



SALT WHITE

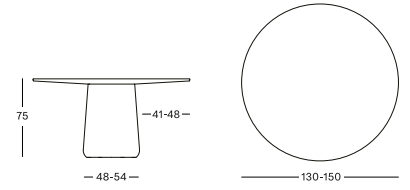



MISTRAL DINING TABLE salt white
SWEEP DINING CHAIR rust | cinnamon

TOMUS

Gracefully curved around a natural teak frame, the seat of Tomus appears to float in the air. The handwoven rope creates a visually light silhouette while adding a rich sense of tactility and craftsmanship to your outdoor space.

Designed by Studio Segers

LOUNGE CHAIR





TOMUS LOUNGE CHAIR

MATERIALS

polypropylene rope
untreated teak

COLOURS



UNTREATED TEAK
FLAX

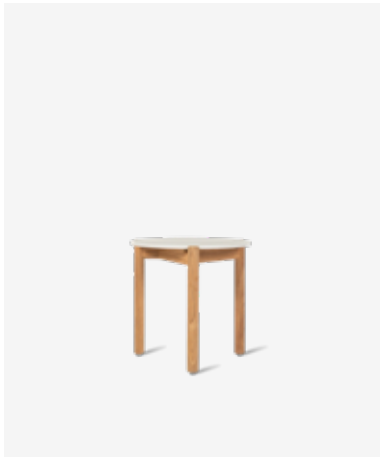
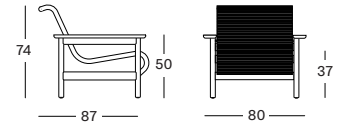

ODA SIDE TABLE DIA 45

MATERIALS

untreated teak
ceramic

DIMENSIONS

45 cm H x Ø 45 cm

COLOURS



UNTREATED TEAK
FLINT CERAMIC



UNTREATED TEAK
SHARDS CERAMIC



UNTREATED TEAK
PORTLAND CERAMIC

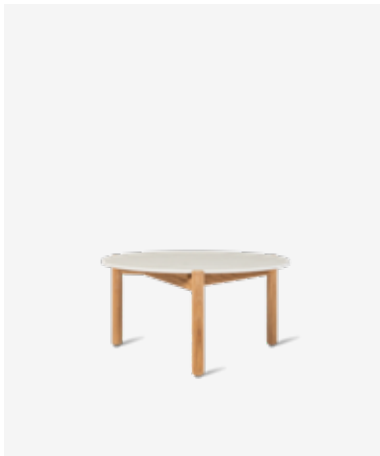
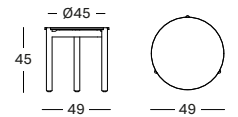

ODA COFFEE TABLE DIA 68

MATERIALS

untreated teak
ceramic

DIMENSIONS

35 cm H x Ø 68 cm

COLOURS



UNTREATED TEAK
FLINT CERAMIC



UNTREATED TEAK
SHARDS CERAMIC



UNTREATED TEAK
PORTLAND CERAMIC

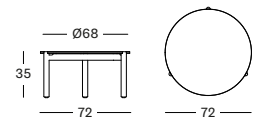

ODA COFFEE TABLE DIA 90

MATERIALS

untreated teak
ceramic

DIMENSIONS

30 cm H x Ø 90 cm

COLOURS



UNTREATED TEAK
FLINT CERAMIC



UNTREATED TEAK
SHARDS CERAMIC



UNTREATED TEAK
PORTLAND CERAMIC

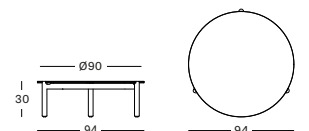



TOMUS LOUNGE CHAIR
ODA SIDE TABLE ceramic portland

FIKA ELKO

Sophisticated details such as a seamless transition from backrest to armrests, a double-woven seat, and high-quality teak wood guarantee outstanding durability and long-lasting comfort.

DINING CHAIR - DINING TABLE





FIKA DINING ARMCHAIR
ELKO DINING TABLE untreated teak | ceramic portland





FIKA DINING ARMCHAIR
ELKO DINING TABLE untreated teak | ceramic portland



FIKA DINING ARMCHAIR

MATERIALS

polypropylene rope
untreated teak

CUSHIONS

seat 2 cm quick dry foam

COLOURS



UNTREATED TEAK
FLAX

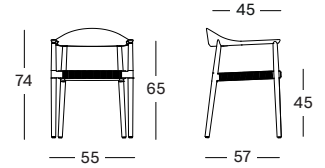

ELKO DINING TABLE

MATERIALS

untreated teak
ceramic top

DIMENSIONS

180 x 90 cm
240 x 100 cm
300 x 110 cm

COLOURS



UNTREATED TEAK
FLINT



UNTREATED TEAK
SHARDS



UNTREATED TEAK
PORTLAND

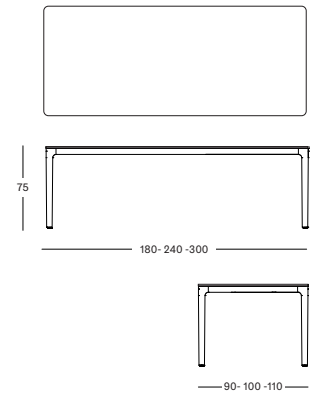

WICKED

By creating an unexpectedly light and airy shape, Belgian designer Alain Gilles managed to shed new light onto the traditional wicker furniture.

LOUNGE CHAIR - LOUNGE SOFA - SIDE TABLE - COFFEE TABLE - DINING CHAIR - DINING TABLE - SUNLOUNGER





WICKED LOUNGE SOFA 3S & LOUNGE CHAIR terracotta | natural
WICKED COFFEE TABLE & SIDE TABLE terracotta | untreated teak
TESSA RECTANGULAR RUG sand





LEFT PAGE: WICKED SUNLOUNGER AND SIDE TABLE terracotta | natural
RIGHT PAGE: WICKED LOUNGE CHAIR AND LOUNGE SOFA 3S white | natural
ROY COCOON camel





WICKED LOUNGE CHAIR AND LOUNGE SOFA 3S black | taupe
WICKED COFFEE AND SIDE TABLE black | untreated teak





WICKED DINING CHAIR

MATERIALS

powder coated aluminium
polyethylene wicker

CUSHIONS

2 cm polyether foam

COLOURS



BLACK
TAUPE



WHITE
NATURAL



TERRACOTTA
NATURAL

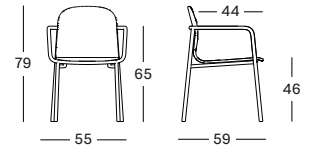

WICKED DINING TABLE

MATERIALS

powder coated aluminium
untreated teak

DIMENSIONS

200 x 90 cm
250 x 90 cm

COLOURS



BLACK ALUMINIUM
UNTREATED TEAK



WHITE ALUMINIUM
UNTREATED TEAK

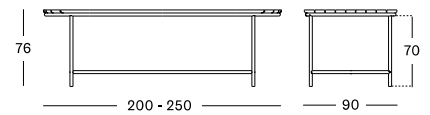
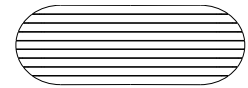

WICKED SIDE TABLE

MATERIALS

powder coated aluminium
untreated teak

DIMENSIONS

51 cm H x Ø 37 cm

COLOURS



BLACK ALUMINIUM
UNTREATED TEAK



WHITE ALUMINIUM
UNTREATED TEAK



TERRACOTTA
UNTREATED TEAK

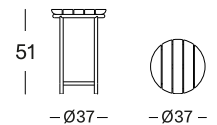

WICKED COFFEE TABLE

MATERIALS

powder coated aluminium
untreated teak

DIMENSIONS

38 cm H x 123 cm x 55 cm

COLOURS



BLACK ALUMINIUM
UNTREATED TEAK



WHITE ALUMINIUM
UNTREATED TEAK



TERRACOTTA
UNTREATED TEAK

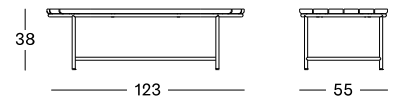



WICKED LOUNGE CHAIR

MATERIALS

powder coated aluminium
polyethylene wicker

CUSHIONS

seat 10 cm quick dry foam
deco 1 x (40x40)

COLOURS



BLACK
TAUPE



WHITE
NATURAL



TERRACOTTA
NATURAL

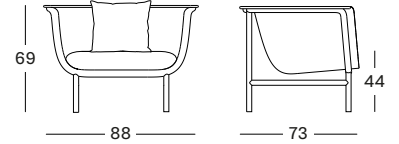

WICKED LOUNGE SOFA 2S

MATERIALS

powder coated aluminium
polyethylene wicker

CUSHIONS

seat 10 cm quick dry foam
deco 2x (45x50), 3x (40x40)

COLOURS



BLACK
TAUPE



WHITE
NATURAL



TERRACOTTA
NATURAL

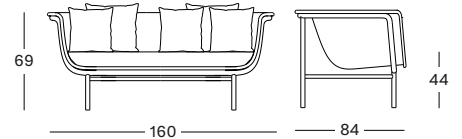

WICKED LOUNGE SOFA 3S

MATERIALS

powder coated aluminium
polyethylene wicker

CUSHIONS

seat 10 cm quick dry foam
deco 3x (45x50), 2x (40x40)

COLOURS



BLACK
TAUPE



WHITE
NATURAL



TERRACOTTA
NATURAL

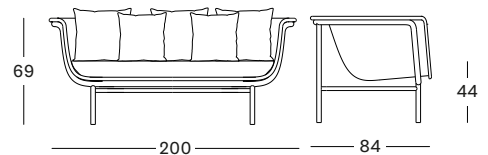

WICKED SUNLOUNGER

MATERIALS

powder coated aluminium
polyethylene wicker

CUSHIONS

seat 10 cm quick dry foam + padding
back 3 cm quick dry foam + padding

COLOURS



TERRACOTTA
NATURAL

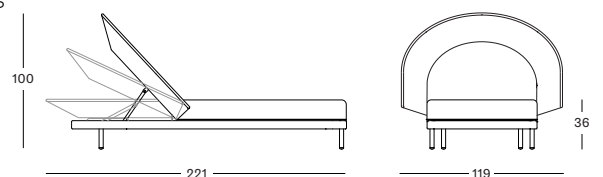

AKARI SANDRO

Enhance the spacious feel of your outdoor setting with the Akari collection and Sandro tables. Their light appearances exude a refined and contemporary aesthetic.

DINING CHAIR - LOUNGE CHAIR - LOUNGE SOFA 2,5S - LOUNGE SOFA 3S - SIDE TABLE - COFFEE TABLE - DINING TABLE - BAR TABLE





AKARI LOUNGE CHAIR AND LOUNGE SOFA 3S
ODA COFFEE TABLES ceramic portland





AKARI DINING CHAIR
SANDRO DINING TABLE RECTANGULAR dune white | ceramic portland





AKARI DINING CHAIR

MATERIALS

powder coated aluminium
acrylic rope

CUSHION

seat 4 cm quick dry foam

COLOURS

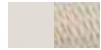

DUNE WHITE
FLAX ROPE

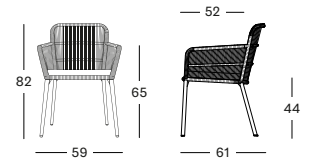

AKARI LOUNGE CHAIR

MATERIALS

powder coated aluminium
acrylic rope

CUSHION

seat 12 cm quick dry foam
back polyester fibre filling

COLOURS

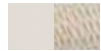

DUNE WHITE
FLAX ROPE

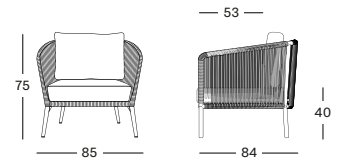

AKARI LOUNGE SOFA 2,5S

MATERIALS

powder coated aluminium
acrylic rope

CUSHIONS

seat 12 cm quick dry foam
back polyester fibre filling

COLOURS

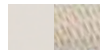

DUNE WHITE
FLAX ROPE

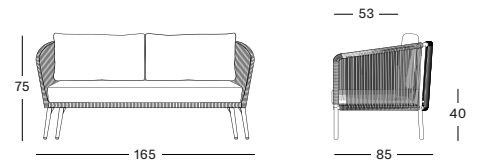

AKARI LOUNGE SOFA 3S

MATERIALS

powder coated aluminium
acrylic rope

CUSHIONS

seat 12 cm quick dry foam
back polyester fibre filling

COLOURS



DUNE WHITE
FLAX ROPE

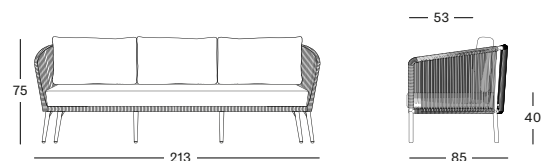



SANDRO BISTRO TABLE ROUND

MATERIALS

powder coated aluminium base
powder coated aluminium or ceramic top

DIMENSIONS

74 cm H x Ø 90 cm (aluminium top)
75 cm H x Ø 90 cm (ceramic top)

COLOURS



DUNE WHITE
PORTLAND CERAMIC



DUNE WHITE
SHARDS CERAMIC



DUNE WHITE
FLINT CERAMIC

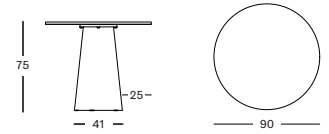
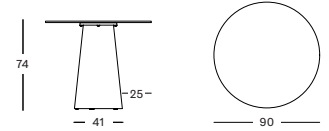

SANDRO DINING TABLE ROUND

MATERIALS

powder coated aluminium base
ceramic top

DIMENSIONS

75 cm H x Ø 120 cm
75 cm H x Ø 150 cm

COLOURS



DUNE WHITE
PORTLAND CERAMIC



DUNE WHITE
SHARDS CERAMIC



DUNE WHITE
FLINT CERAMIC

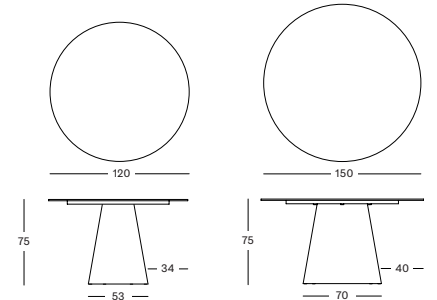

SANDRO DINING TABLE RECTANGULAR

MATERIALS

powder coated aluminium base
ceramic top

DIMENSIONS

75 cm H x 240 cm x 120 cm
75 cm H x 280 cm x 120 cm

COLOURS



DUNE WHITE
PORTLAND CERAMIC



DUNE WHITE
SHARDS CERAMIC



DUNE WHITE
FLINT CERAMIC

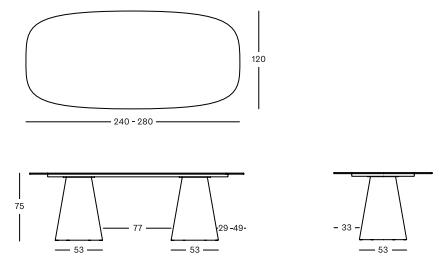

SANDRO BAR TABLE

MATERIALS

powder coated aluminium base
powder coated aluminium or ceramic top

DIMENSIONS

102 cm H x Ø 75 cm (aluminium top)
103 cm H x Ø 75 cm (ceramic top)

COLOURS



DUNE WHITE
PORTLAND CERAMIC



DUNE WHITE
SHARDS CERAMIC



DUNE WHITE
FLINT CERAMIC

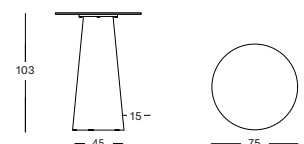
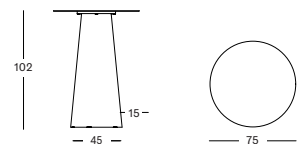

ODA

Warm teak, textured straps and pillow-like cushions create an
ambiance that is both playful and inviting.

DINING CHAIR - LOUNGE CHAIR - LOUNGE SOFA 2,5S - LOUNGE SOFA 3S - SIDE TABLE - COFFEE TABLE - SUNLOUNGER





ODA LOUNGE CHAIRS AND LOUNGE SOFA 2,5S
ODA COFFEE TABLE ceramic portland





ODA SUNLOUNGER
ODA SIDE TABLE ceramic portland





ODA DINING CHAIR

MATERIALS

untreated teak
polypropylene straps

CUSHION

seat 3 cm quick dry foam
back polyester fibre filling

COLOURS



UNTREATED TEAK
FLAX STRAP

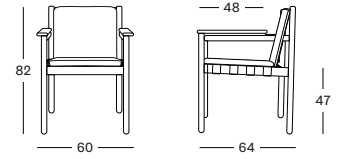

ODA LOUNGE CHAIR

MATERIALS

untreated teak
polypropylene straps

CUSHION

seat 14 cm quick dry foam
back polyester fibre filling

COLOURS



UNTREATED TEAK
FLAX STRAP

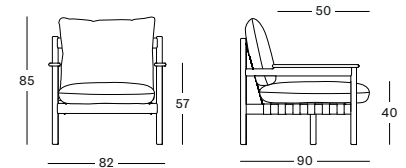

ODA LOUNGE SOFA 2,5S

MATERIALS

untreated teak
polypropylene straps

CUSHIONS

seat 14 cm quick dry foam
back polyester fibre filling

COLOURS



UNTREATED TEAK
FLAX STRAP

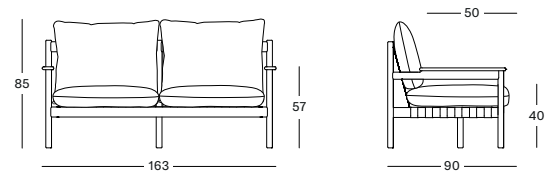

ODA LOUNGE SOFA 3S

MATERIALS

untreated teak
polypropylene straps

CUSHIONS

seat 14 cm quick dry foam
back polyester fibre filling

COLOURS



UNTREATED TEAK
FLAX STRAP

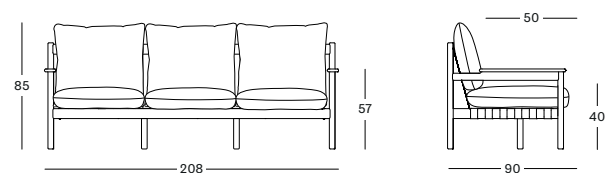



ODA SUNLOUNGER

MATERIALS

untreated teak
polypropylene straps

CUSHION

seat 8 cm quick dry foam
back polyester fibre filling

COLOURS



UNTREATED TEAK
FLAX STRAP

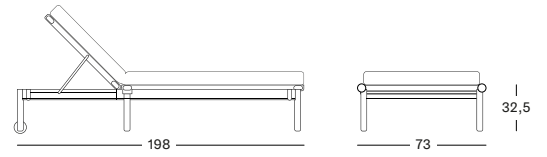

ODA DINING ARMCHAIR
RONDA BISTRO TABLE untreated teak



ODA COFFEE TABLES ceramic portland

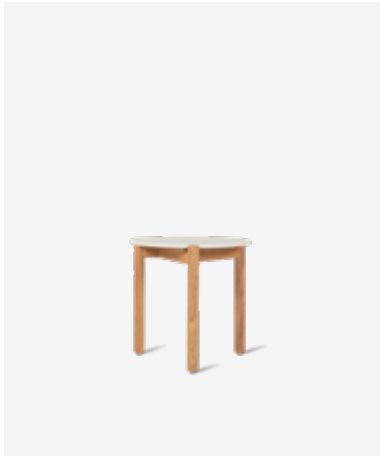

ODA SIDE TABLE DIA 45

MATERIALS

untreated teak
ceramic

DIMENSIONS

45 cm H x Ø 45 cm

COLOURS



UNTREATED TEAK
FLINT CERAMIC



UNTREATED TEAK
SHARDS CERAMIC



UNTREATED TEAK
PORTLAND CERAMIC

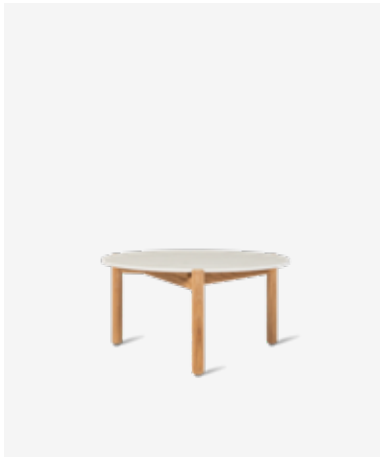
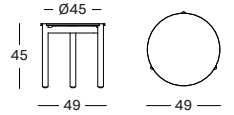

ODA COFFEE TABLE DIA 68

MATERIALS

untreated teak
ceramic

DIMENSIONS

35 cm H x Ø 68 cm

COLOURS



UNTREATED TEAK
FLINT CERAMIC



UNTREATED TEAK
SHARDS CERAMIC



UNTREATED TEAK
PORTLAND CERAMIC

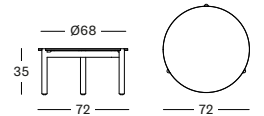

ODA COFFEE TABLE DIA 90

MATERIALS

untreated teak
ceramic

DIMENSIONS

30 cm H x Ø 90

COLOURS



UNTREATED TEAK
FLINT CERAMIC



UNTREATED TEAK
SHARDS CERAMIC



UNTREATED TEAK
PORTLAND CERAMIC

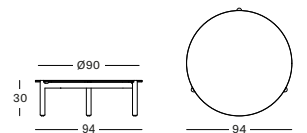

ODA COFFEE TABLE 129X53

MATERIALS

untreated teak
ceramic

DIMENSIONS

30 cm H x 51 cm x 129 cm

COLOURS



UNTREATED TEAK
FLINT CERAMIC



UNTREATED TEAK
SHARDS CERAMIC



UNTREATED TEAK
PORTLAND CERAMIC

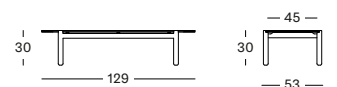

FRIDA

A distinctive design with a spacious back, round frame and tactile seat. Beautiful from all sides and angles.

LOUNGE CHAIR - DINING CHAIR





FRIDA LOUNGE CHAIR anthracite
ANTON COFFEE TABLE





FRIDA DINING CHAIR anthracite





FRIDA DINING CHAIR dune white
NOA DINING TABLE



FRIDA DINING CHAIR

MATERIALS

untreated teak
polypropylene rope

CUSHION

2 cm polyether foam

COLOURS



UNTREATED TEAK
ANTHRACITE ROPE



UNTREATED TEAK
DUNE WHITE ROPE



UNTREATED TEAK
DARK GREEN ROPE

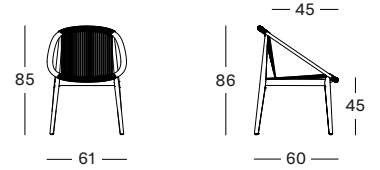

FRIDA LOUNGE CHAIR

MATERIALS

untreated teak or brushed black teak
polypropylene rope

CUSHION

2 cm polyether foam

COLOURS



UNTREATED TEAK
ANTHRACITE ROPE



UNTREATED TEAK
DUNE WHITE ROPE



UNTREATED TEAK
DARK GREEN ROPE



BRUSHED BLACK
ONYX ROPE

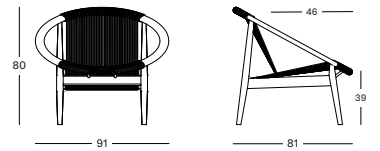

ANTON SIDE & COFFEE TABLE

MATERIALS

untreated teak

DIMENSIONS

40,5 cm H x Ø 40 cm

34,5 cm H x Ø 70 cm

COLOURS



UNTREATED TEAK

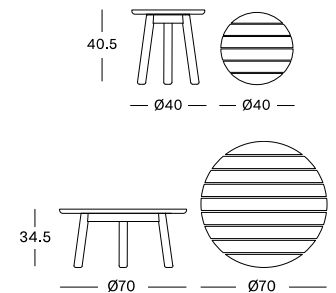

NOA DINING TABLE

MATERIALS

untreated teak
powder coated aluminium connection

DIMENSIONS

75 cm H x Ø 90 cm

75 cm H x Ø 132 cm

75 cm H x Ø 150 cm

COLOUR



UNTREATED TEAK

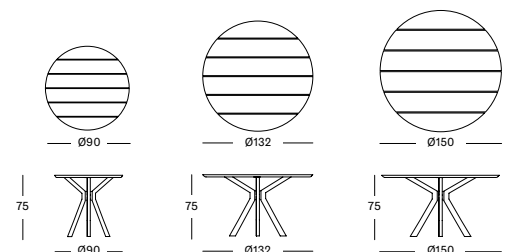

KODO

Contemporary outdoor elegance which beckons both comfort and style. With its soft curves and rounded backs the Kodo collection exudes a warm and inviting ambience. Designed by Studio Segers.

LOUNGE CHAIR - COCOON - ROCKING CHAIR - LOUNGE SOFA - MODULAR SOFA - DEEP SOFA - FOOTREST - SUNLOUNGER
SIDE TABLE - COFFEE TABLE - DAYBED - DINING CHAIR - DINING TABLE - BAR STOOL





KODO LOUNGE SOFA dune white
KODO COFFEE TABLE dune white | ceramic shards



KODO DINING CHAIR fossil grey
KODO DINING TABLE fossil grey | ceramic flint





KODO MODULAR SOFA AND ROCKING CHAIR dune white
KODO ROUND COFFEE AND SIDE TABLE dune white | ceramic portland



KODO DAYBED fossil grey
MORA LANTERNS fossil grey





KODO SUNLOUNGER dune white
KODO ROUND SIDE TABLE dune white | ceramic shards



SANDRO BAR TABLE dune white | ceramic portland
KODO BAR STOOL dune white



KODO DINING CHAIR

MATERIALS

powder coated aluminium
polypropylene rope

CUSHIONS

seat 4 cm quick dry foam

COLOURS



FOSSIL GREY



DUNE WHITE

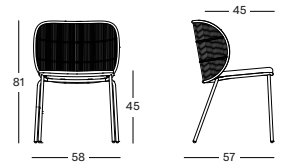

KODO LOUNGE CHAIR

MATERIALS

powder coated aluminium
polypropylene rope

CUSHIONS

seat 12 cm quick dry foam
deco 1x (50x50), 1x (40x40)

COLOURS

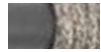

FOSSIL GREY



DUNE WHITE



RUST
CINNAMON

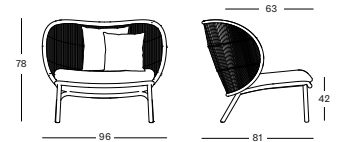

KODO COCOON

MATERIALS

powder coated aluminium
polypropylene rope

CUSHIONS

- seat 12 cm quick dry foam + deco 1x (60x60), 2x (40x40)
- seat 12 cm quick dry foam + back polyester fibre filling and deco 1x (35x50)

COLOURS

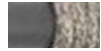

FOSSIL GREY



DUNE WHITE



RUST
CINNAMON

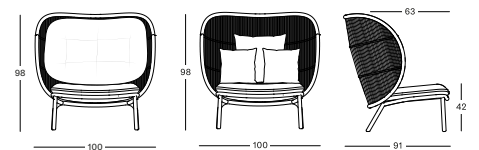

KODO FOOTREST

MATERIALS

powder coated aluminium

CUSHION

footrest 12 cm quick dry foam

COLOURS



FOSSIL GREY



DUNE WHITE



RUST

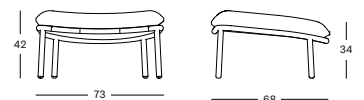



KODO LOUNGE SOFA

MATERIALS

powder coated aluminium
polypropylene rope

CUSHIONS

seat 12 cm quick dry foam
deco 2x (50x50), 3x (40x40)

COLOURS



FOSSIL GREY



DUNE WHITE



RUST CINNAMON

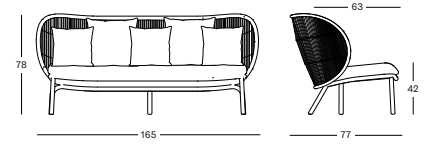

KODO ROCKING CHAIR

MATERIALS

powder coated aluminium and teak slats
polypropylene rope

CUSHIONS

- seat 12 cm quick dry foam + deco 1x (60 x 60), 2x (40x40)
- seat 12 cm quick dry foam + back polyester fibre filling and deco 1x (35x50)

COLOURS



FOSSIL GREY



DUNE WHITE



RUST CINNAMON

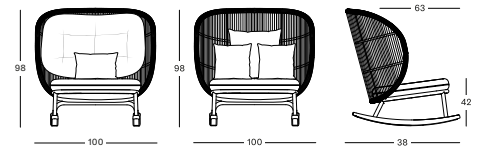

KODO DAYBED

MATERIALS

powder coated aluminium
polypropylene rope

CUSHIONS

seat 12 cm quick dry foam
deco 2x (60x60), 3x (50x50), 2x (40x40)

COLOURS



FOSSIL GREY



DUNE WHITE

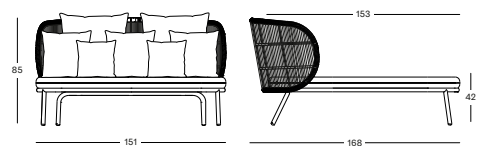

KODO DINING TABLE

MATERIALS

powder coated aluminium
ceramic top

DIMENSIONS

210 x 100 cm
280 x 106 cm

COLOURS



FOSSIL GREY
FLINT CERAMIC



DUNE WHITE
PORTLAND CERAMIC



DUNE WHITE
SHARDS CERAMIC

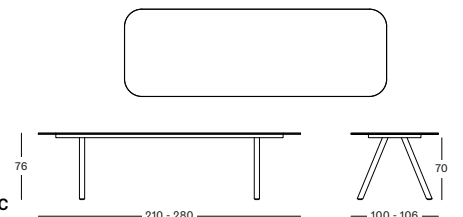



KODO MODULAR 1 SEATER RIGHT

MATERIALS

powder coated aluminium
polypropylene rope

CUSHION

seat 14 cm quick dry foam
back polyester fibre filling

COLOURS



DUNE WHITE

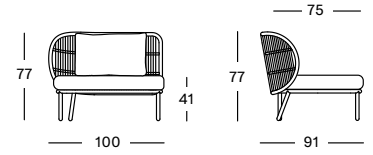

KODO MODULAR 2 SEATER RIGHT

MATERIALS

powder coated aluminium
polypropylene rope

CUSHIONS

seat 14 cm quick dry foam
back polyester fibre filling

COLOURS



DUNE WHITE

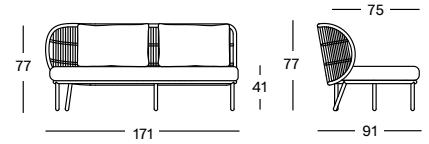

KODO MODULAR CHAISE LONGUE RIGHT

MATERIALS

powder coated aluminium
polypropylene rope

CUSHION

seat 14 cm quick dry foam
back polyester fibre filling

COLOURS



DUNE WHITE

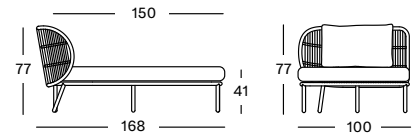

KODO MODULAR CENTER

MATERIALS

powder coated aluminium
polypropylene rope

CUSHIONS

seat 14 cm quick dry foam
back polyester fibre filling

COLOURS



DUNE WHITE

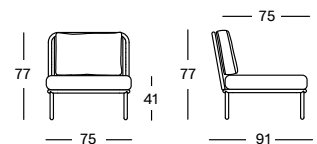



KODO MODULAR 1 SEATER LEFT

MATERIALS

powder coated aluminium
polypropylene rope

CUSHION

seat 14 cm quick dry foam
back polyester fibre filling

COLOURS



DUNE WHITE

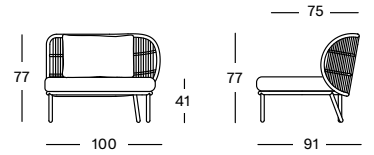

KODO MODULAR 2 SEATER LEFT

MATERIALS

powder coated aluminium
polypropylene rope

CUSHIONS

seat 14 cm quick dry foam
back polyester fibre filling

COLOURS



DUNE WHITE

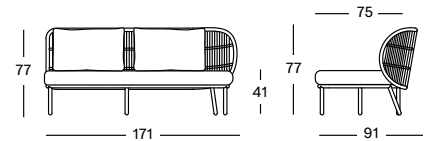

KODO MODULAR CHAISE LONGUE LEFT

MATERIALS

powder coated aluminium
polypropylene rope

CUSHION

seat 14 cm quick dry foam
back polyester fibre filling

COLOURS



DUNE WHITE

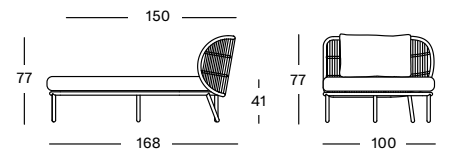

KODO MODULAR CORNER

MATERIALS

powder coated aluminium
polypropylene rope

CUSHIONS

seat 14 cm quick dry foam
back polyester fibre filling

COLOURS



DUNE WHITE

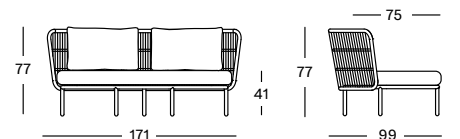



KODO DEEP SOFA

MATERIALS

powder coated aluminium
polypropylene rope

CUSHIONS

seat 14 cm quick dry foam
back polyester fibre filling

COLOURS



FOSSIL GREY



DUNE WHITE

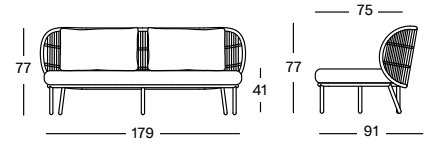

KODO MODULAR OTTOMAN

MATERIALS

powder coated aluminium

CUSHIONS

seat 14 cm quick dry foam

COLOURS



DUNE WHITE

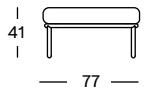

KODO MODULAR CONNECTING SIDE TABLE

MATERIALS

powder coated aluminium

DIMENSIONS

75 x 59 cm

75 x 75 cm

COLOURS



DUNE WHITE

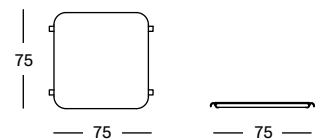
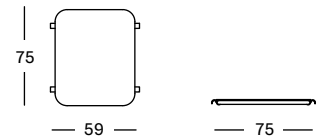

KODO SUNLOUNGER

MATERIALS

powder coated aluminium
polypropylene rope

CUSHIONS

3 cm polyether foam filling

COLOURS



FOSSIL GREY



DUNE WHITE

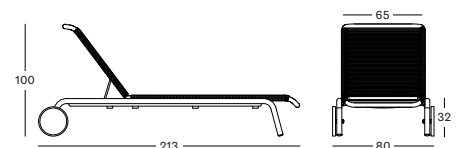



KODO ROUND SIDE TABLE

MATERIALS

powder coated aluminium base
powder coated aluminium or ceramic top

DIMENSIONS

43 cm H x Ø 37 cm (aluminium top)
44 cm H x Ø 40 cm (ceramic top)

COLOURS



FOSSIL GREY
FLINT CERAMIC



DUNE WHITE
PORTLAND CERAMIC



DUNE WHITE
SHARDS CERAMIC

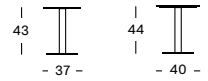

KODO ROUND COFFEE TABLE DIA 68 & DIA 90

MATERIALS

powder coated aluminium base
powder coated aluminium or ceramic top

DIMENSIONS

36 cm H x Ø 65 cm (aluminium) or Ø 68 cm (ceramic)
30 cm H x Ø 87 cm (aluminium) or Ø 90 cm (ceramic)

COLOURS



FOSSIL GREY
FLINT CERAMIC



DUNE WHITE
PORTLAND CERAMIC



DUNE WHITE
SHARDS CERAMIC

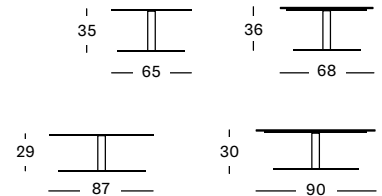

KODO COFFEE TABLE

MATERIALS

powder coated aluminium base
powder coated aluminium or ceramic top

DIMENSIONS

31 cm H x 127 cm x 43 cm (aluminium top)
31 cm H x 129 cm x 45 cm (ceramic top)

COLOURS



FOSSIL GREY
FLINT CERAMIC



DUNE WHITE
PORTLAND CERAMIC



DUNE WHITE
SHARDS CERAMIC

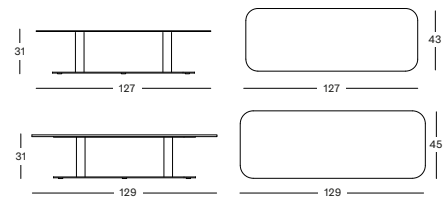

KODO SIDE TABLE

MATERIALS

powder coated aluminium base
powder coated aluminium or ceramic top

DIMENSIONS

42 cm H x 39 cm x 39 cm (aluminium top)
44 cm H x 41 cm x 41 cm (ceramic top)

COLOURS



FOSSIL GREY
FLINT CERAMIC



DUNE WHITE
PORTLAND CERAMIC



DUNE WHITE
SHARDS CERAMIC

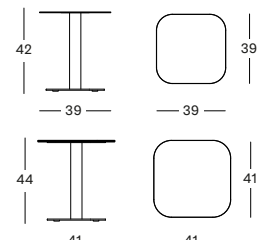





KODO BAR STOOL

MATERIALS

powder coated aluminium
polypropylene rope

CUSHIONS

seat 2 cm quick dry foam

COLOURS



FOSSIL GREY



DUNE WHITE

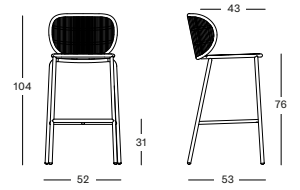

SANDRO BAR TABLE

MATERIALS

aluminium base
aluminium or ceramic top

DIMENSIONS

102 cm H x Ø 75 cm (aluminium top)

103 cm H x Ø 75 cm (ceramic top)

COLOURS



DUNE WHITE
PORTLAND CERAMIC



DUNE WHITE
SHARDS CERAMIC



DUNE WHITE
FLINT CERAMIC

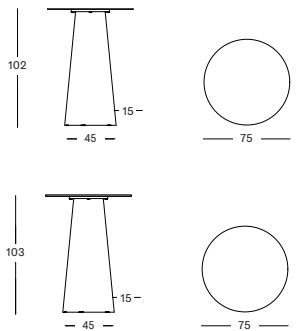

LENTO

Prominently featured solid teak legs and high woven rope backs give the collection a rich and engaging personality.
Designed by Bertrand Lejoly.

LOUNGE CHAIR - LOUNGE SOFA - MODULAR SOFA - COFFEE TABLES - SIDE TABLES





LENTO LOUNGE CHAIR AND MODULAR SOFA
LENTO COFFEE TABLES ceramic portland





LENTO LOUNGE SOFA 2,5S
LENTO COFFEE AND SIDE TABLE



LENTO LOUNGE CHAIR

MATERIALS

untreated teak
polypropylene rope

CUSHIONS

- combi 1: seat 12 cm quick dry foam + back polyester fibre filling
- combi 2: seat 12 cm quick dry foam + deco 1 x (50x50), 1 x (40x40)

COLOURS



UNTREATED TEAK
ANTHRACITE ROPE

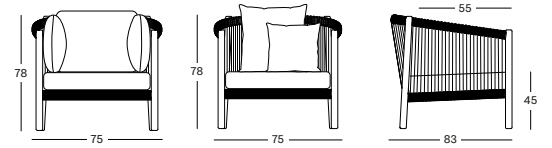

LENTO LOUNGE SOFA 2,5S

MATERIALS

untreated teak
polypropylene rope

CUSHIONS

seat 12 cm quick dry foam
back polyester fibre filling

COLOURS

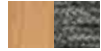

UNTREATED TEAK
ANTHRACITE ROPE

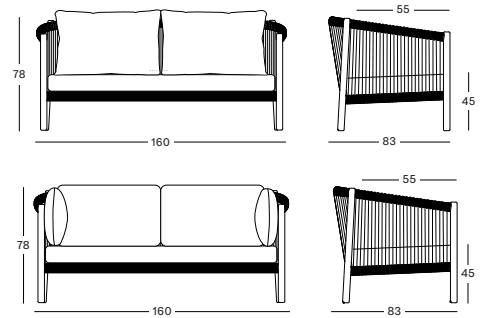

LENTO LOUNGE SOFA 3S

MATERIALS

untreated teak
polypropylene rope

CUSHIONS

seat 12 cm quick dry foam
back polyester fibre filling

COLOURS



UNTREATED TEAK
ANTHRACITE ROPE

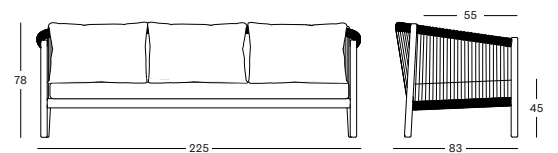

LENTO COFFEE AND SIDE TABLES

MATERIALS

untreated teak and aluminium frame
ceramic top

DIMENSIONS

44 cm H x Ø 45 cm
34 cm H x Ø 68 cm
29 cm H x Ø 90 cm

COLOURS



UNTREATED TEAK
PORTLAND CERAMIC

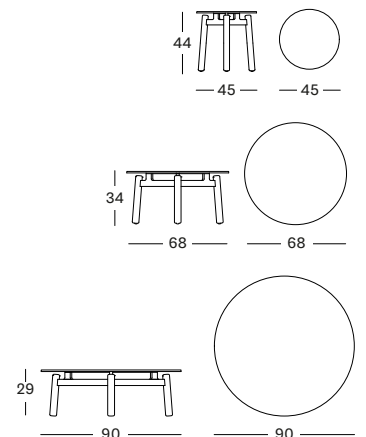



LENTO MODULAR CORNER RIGHT

MATERIALS

untreated teak
polypropylene rope

CUSHIONS

seat 12 cm quick dry foam
back polyester fibre filling

COLOURS



UNTREATED TEAK
ANTHRACITE ROPE

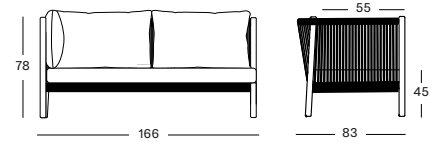

LENTO MODULAR CORNER LEFT

MATERIALS

untreated teak
polypropylene rope

CUSHIONS

seat 12 cm quick dry foam
back polyester fibre filling

COLOURS



UNTREATED TEAK
ANTHRACITE ROPE

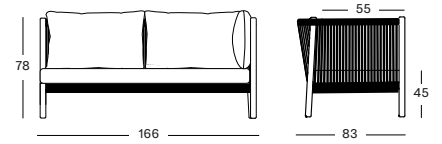

LENTO MODULAR CONNECTING SIDE TABLE

MATERIALS

polypropylene rope
ceramic top

DIMENSIONS

69 x 37 cm

COLOURS

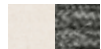

PORTLAND CERAMIC
ANTHRACITE ROPE





LENTO MODULAR CHAISE LONGUE LEFT

MATERIALS

untreated teak
polypropylene rope

CUSHIONS

seat 12 cm quick dry foam
back polyester fibre filling

COLOURS



UNTREATED TEAK
ANTHRACITE ROPE

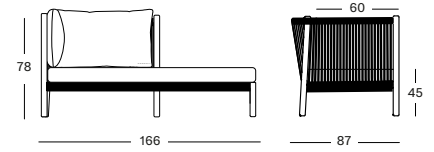

LENTO MODULAR CHAISE LONGUE RIGHT

MATERIALS

untreated teak
polypropylene rope

CUSHIONS

seat 12 cm quick dry foam
back polyester fibre filling

COLOURS



UNTREATED TEAK
ANTHRACITE ROPE

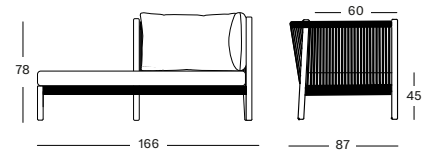

LENTO MODULAR OTTOMAN

MATERIALS

untreated teak
polypropylene rope

CUSHIONS

seat 12 cm quick dry foam

COLOURS



UNTREATED TEAK
ANTHRACITE ROPE

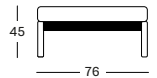

ROY

The Roy collection combines nostalgic design with innovative materials, giving your outdoor space a strong graphic twist.

DINING CHAIR - LAZY CHAIR - COCOON





ROXANNE DINING CHAIR black
RONDA BISTRO TABLE untreated teak



ROXY DINING CHAIR camel
LEO SIDE TABLE lava





LEFT PAGE: ROY COCOON black
RIGHT PAGE: ROY LAZY CHAIR camel



SPHERA BISTRO TABLE

MATERIALS

black epoxy and powder coated steel base
untreated teak or black hpl top

DIMENSIONS

75 cm H x Ø 80 cm
76 cm H x Ø 80 cm

COLOURS



UNTREATED BLACK
TEAK HPL

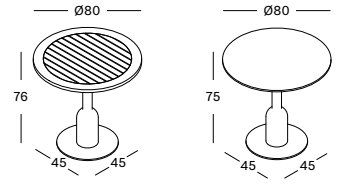

RONDA BISTRO TABLE

MATERIALS

black epoxy and powder coated steel base
untreated teak top or black hpl top

DIMENSIONS

75 cm H x Ø 110 cm (hpl)
76 cm H x Ø 110 cm (teak)

COLOURS



UNTREATED BLACK
TEAK HPL

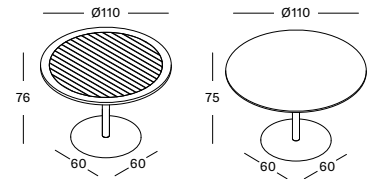

QUADRO BISTRO TABLE

MATERIALS

black powder coated steel base
untreated teak or hpl top

DIMENSIONS

75 cm H x 70 cm x 70 cm (hpl)
76 cm H x 70 cm x 70 cm (teak)

COLOURS



UNTREATED BLACK
TEAK HPL

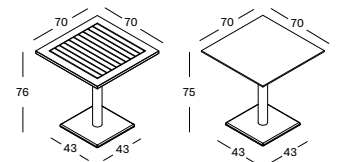

MAX DINING TABLE SQUARE

MATERIALS

powder coated aluminium frame
untreated teak, black hpl or ceramic top

DIMENSIONS

75 cm H x 90 cm x 90 cm

COLOURS

see website

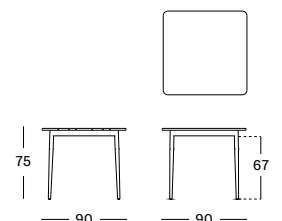



ROXANNE DINING CHAIR

MATERIALS

aluminium and polyethylene wicker seat
black epoxy and powder coated steel base

CUSHIONS

seat 2 cm polyether foam

COLOURS

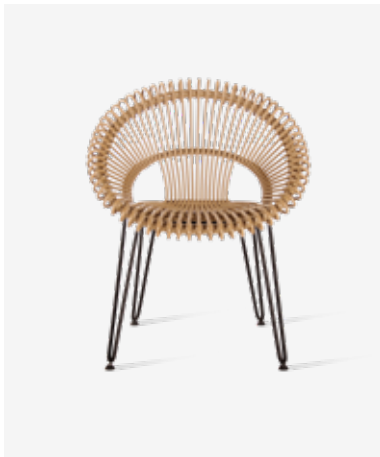
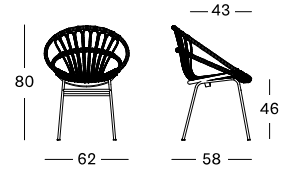

ROXY DINING CHAIR

MATERIALS

aluminium and polyethylene wicker seat
black epoxy and powder coated steel base

CUSHIONS

seat 2 cm polyether foam

COLOURS

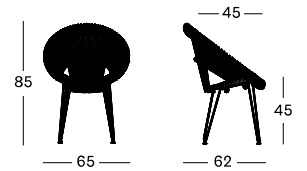

ROY LAZY CHAIR

MATERIALS

aluminium and polyethylene wicker seat
black epoxy and powder coated steel base

CUSHIONS

seat 2 cm polyether foam

COLOURS

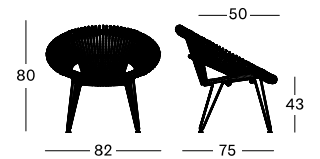

ROY COCOON

MATERIALS

aluminium and polyethylene wicker seat
black epoxy and powder coated steel base

CUSHIONS

seat 8 cm quick dry foam

COLOURS

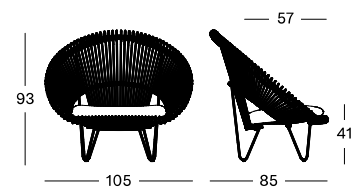

LUCY

Lucy will inject your terrace and garden with charm and comfort. The soft, flowing round shapes of these chairs invite you to relax in the sun.

LAZY ARMCHAIR - FOOTREST - SIDE TABLE - MODULAR SOFA - DINING CHAIR - SUNLOUNGER





LEFT PAGE: LUCY DINING ARMCHAIR off white
RIGHT PAGE: LUCY LAZY ARMCHAIR AND FOOTREST off white







LUCY MODULAR off white



LUCY SUNLOUNGER

MATERIALS

powder coated aluminium
polyethylene fibre

CUSHION

seat 3 cm polyether foam

COLOUR



OFF WHITE

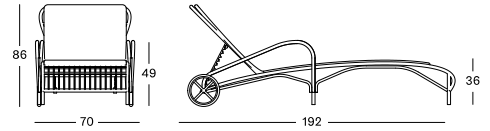

LUCY SIDE TABLE

MATERIALS

powder coated aluminium
polyethylene fibre
glass top

COLOUR



OFF WHITE

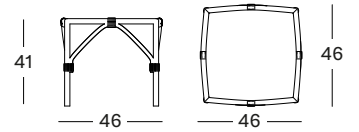



LUCY DINING CHAIR

MATERIALS

powder coated aluminium
polyethylene fibre

CUSHION

seat 2 cm polyether foam

COLOUR



OFF WHITE

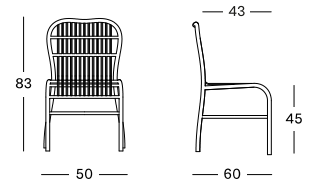

LUCY DINING ARMCHAIR

MATERIALS

powder coated aluminium
polyethylene fibre

CUSHION

seat 2 cm polyether foam

COLOUR



OFF WHITE

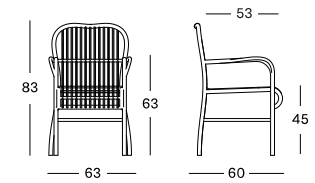

LUCY LAZY ARMCHAIR

MATERIALS

powder coated aluminium
polyethylene fibre

CUSHION

seat 2 cm polyether foam

COLOUR



OFF WHITE

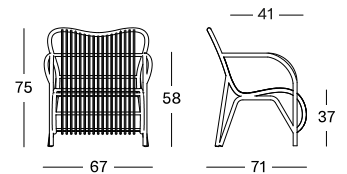

LUCY FOOTREST

MATERIALS

powder coated aluminium
polyethylene fibre

COLOUR



OFF WHITE

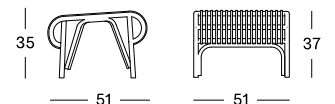





LUCY MODULAR CORNER

MATERIALS

powder coated aluminium
polyethylene fibre

CUSHIONS

seat 12 cm quick dry foam
back polyester fibre

COLOUR



OFF WHITE

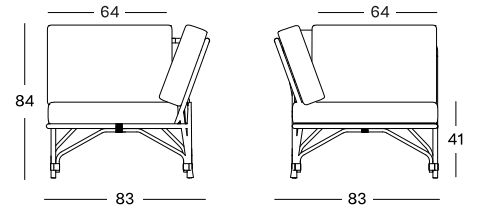

LUCY MODULAR CENTER

MATERIALS

powder coated aluminium
polyethylene fibre

CUSHIONS

seat 12 cm quick dry foam
back polyester fibre

COLOUR



OFF WHITE

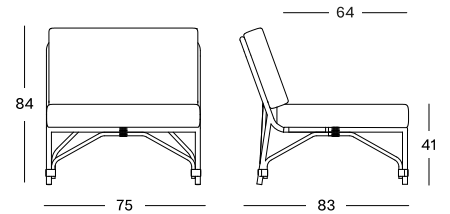

LUCY OTTOMAN

MATERIALS

powder coated aluminium
polyethylene fibre

CUSHIONS

seat 12 cm quick dry foam

COLOUR



OFF WHITE

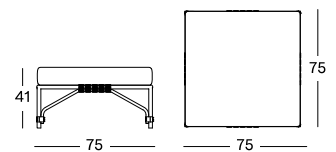

LUCY MODULAR COFFEE TABLE

MATERIALS

powder coated aluminium
polyethylene fibre
glass

DIMENSIONS

29 cm H x 75 cm x 75 cm

COLOUR



OFF WHITE

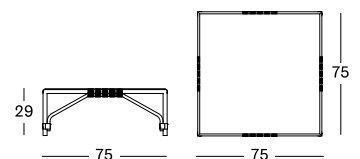

LOOP LILO

From bold earthy colours to calm neutrals, Loop and Lilo bring a light, airy presence to any setting. Their slim profiles balance generous comfort with a sense of space, embodying design that is both striking and effortlessly functional.

DINING CHAIR - LOUNGE CHAIR - SOFA - SIDE TABLE - COFFEE TABLE - FOOTREST - SUNLOUNGER





LEFT PAGE: LOOP LOUNGE CHAIR AND LOOP SIDE TABLE fossil grey
RIGHT PAGE: LOOP DINING CHAIR moss





LOOP LOUNGE CHAIR rust
LILO SIDE TABLE rust





LEFT PAGE: LOOP LOUNGE CHAIR, LOUNGE SOFA, COFFEE TABLE AND SIDE TABLE fossil grey
RIGHT PAGE: LOOP SUNLOUNGER & SIDE TABLE black





LOOP DINING CHAIR

MATERIALS

powder coated aluminium

- polyethylene fibre (black)
- polypropylene rope (other colours)

COLOURS



BLACK



DUNE WHITE



TAUPE



RUST

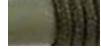

MOSS



TERRACOTTA



FOSSIL GREY

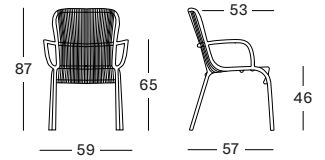

LOOP LOUNGE CHAIR

MATERIALS

powder coated aluminium

- polyethylene fibre (black)
- polypropylene rope (other colours)

COLOURS



BLACK



DUNE WHITE



TAUPE



RUST

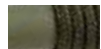

MOSS



TERRACOTTA



FOSSIL GREY

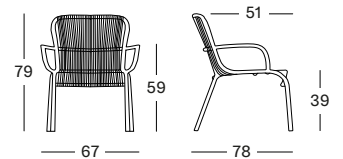

LOOP FOOTREST

MATERIALS

powder coated aluminium

- polyethylene fibre (black)
- polypropylene rope (other colours)

COLOURS



BLACK



DUNE WHITE



TAUPE



RUST



MOSS



TERRACOTTA



FOSSIL GREY

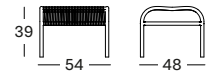

LOOP SOFA

MATERIALS

powder coated aluminium

- polyethylene fibre (black)
- polypropylene rope (other colours)

COLOURS



BLACK



TAUPE



DUNE WHITE



RUST

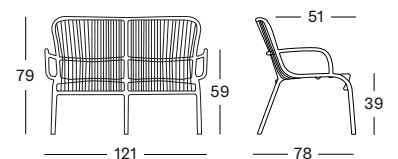



LOOP SUNLOUNGER

MATERIALS

powder coated aluminium

- polyethylene fibre (black)
- polypropylene rope (other colours)

CUSHIONS

3 cm polyether foam

COLOURS



BLACK



DUNE WHITE



TAUPE



FOSSIL GREY

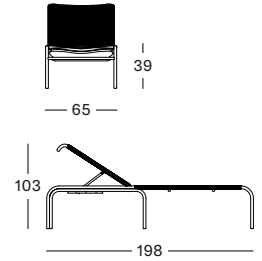

LOOP SIDE TABLE

MATERIALS

powder coated aluminium

- polyethylene fibre (black)
- polypropylene rope (other colours)

COLOURS



BLACK



DUNE WHITE



TAUPE



RUST

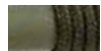

MOSS



TERRACOTTA



FOSSIL GREY

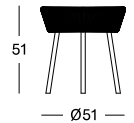

LILO SIDE TABLE

MATERIALS

powder coated aluminium

COLOURS



MOSS



TERRACOTTA



BLACK



DUNE WHITE



FOSSIL GREY



RUST



TAUPE



SAGE GREEN

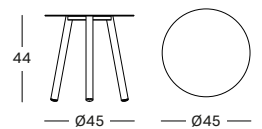

LILO COFFEE TABLE

MATERIALS

powder coated aluminium

COLOURS



MOSS



TERRACOTTA



BLACK



DUNE WHITE



FOSSIL GREY



RUST



TAUPE



SAGE GREEN

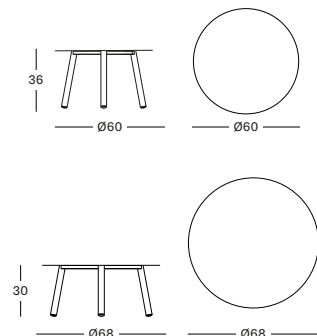

DAVID

David's woven back and rope details in a soft earthy tone match perfectly with the solid teak frame and add a sense of tactility.

LOUNGE CHAIR - LOUNGE SOFA - SUNLOUNGER - SIDE TABLE - COFFEE TABLE - DINING TABLE - DINING ARMCHAIR







DAVID LOUNGE SOFA 2S, LOUNGE CHAIR, COFFEE AND SIDE TABLE



LEFT PAGE: DAVID DINING ARMCHAIR AND DINING TABLE
RIGHT PAGE: DAVID SUNLOUNGER





DAVID DINING ARMCHAIR

MATERIALS

stained brushed teak
polypropylene rope

CUSHION

4 cm quick dry foam

COLOURS



AGED TEAK

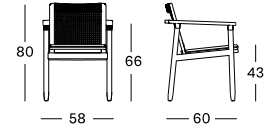

DAVID DINING TABLE

MATERIALS

stained brushed teak
ceramic top

DIMENSIONS

210 x 100 cm
280 x 106 cm

COLOURS



AGED TEAK
FLINT CERAMIC

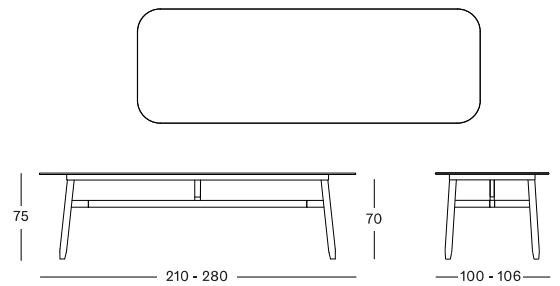

DAVID ROUND COFFEE & SIDE TABLE

MATERIALS

stained brushed teak
ceramic top

DIMENSIONS

side table: 40 cm H x Ø 40 cm
coffee table: 34 cm H x Ø 68 cm

COLOURS



AGED TEAK
FLINT CERAMIC

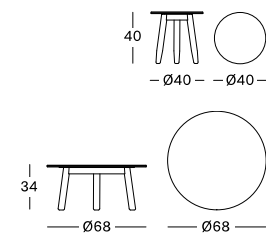

DAVID COFFEE AND SIDE TABLE

MATERIALS

stained brushed teak
ceramic top

DIMENSIONS

side table: 41 x 41 cm
coffee table: 120 x 120 cm
coffee table: 129 x 45 cm

COLOURS



AGED TEAK
FLINT CERAMIC

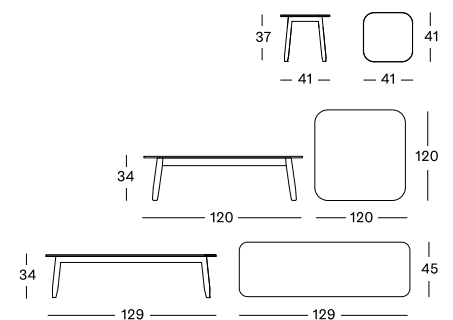



DAVID LOUNGE CHAIR

MATERIALS

stained brushed teak
polypropylene rope

CUSHIONS

seat 12 cm quick dry foam
back polyester fibre filling

COLOURS



AGED TEAK

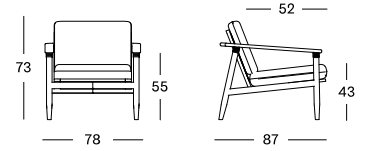

DAVID LOUNGE SOFA 2S

MATERIALS

stained brushed teak
polypropylene rope

CUSHIONS

seat 12 cm quick dry foam
back polyester fibre filling

COLOURS



AGED TEAK

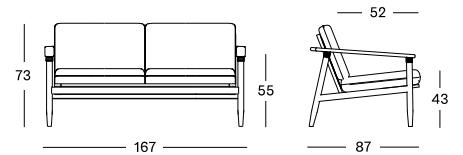

DAVID LOUNGE SOFA 3S

MATERIALS

stained brushed teak
polypropylene rope

CUSHIONS

seat 12 cm quick dry foam
back polyester fibre filling

COLOURS



AGED TEAK

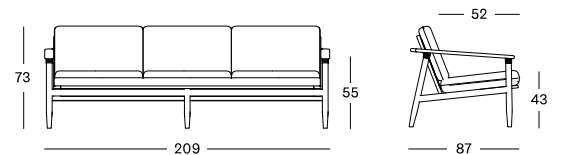

DAVID SUNLOUNGER

MATERIALS

stained brushed teak
polypropylene rope

CUSHION

6 cm quick dry foam

COLOURS



AGED TEAK

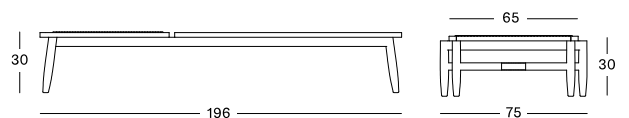

FREYA
MONA
NOA
REMI
SAM
VOLTA

Renowned for its resilience and timeless beauty, teak has the power to transform any space into a sanctuary of elegance.

DINING CHAIRS - DINING TABLES





FREYA DINING ARMCHAIR
VOLTA DINING TABLE



REMI DINING CHAIR fossil grey
NOA DINING TABLE







MONA DINING CHAIR old lace





VOLTA DINING TABLE

MATERIALS

ceramic top
untreated teak frame

DIMENSIONS

75 cm H x 240 cm x 100 cm
75 cm H x 310 cm x 100 cm

COLOUR



UNTREATED TEAK
MASAI BLANCO CERAMIC

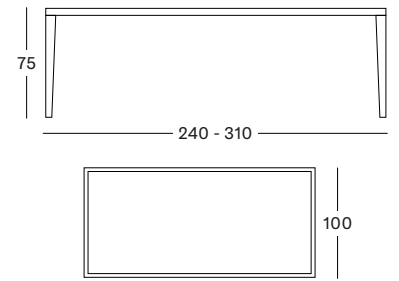

SAM DINING TABLE

MATERIALS

untreated solid teak

DIMENSIONS

75 cm H x Ø 120 cm

COLOUR



UNTREATED TEAK

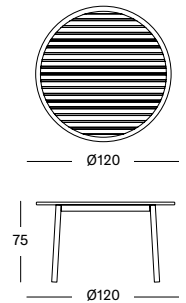

NOA DINING TABLE

MATERIALS

untreated solid teak
powder coated aluminium connection

DIMENSIONS

75 cm H x Ø 90 cm
75 cm H x Ø 132 cm
75 cm H x Ø 150 cm

COLOUR



UNTREATED TEAK

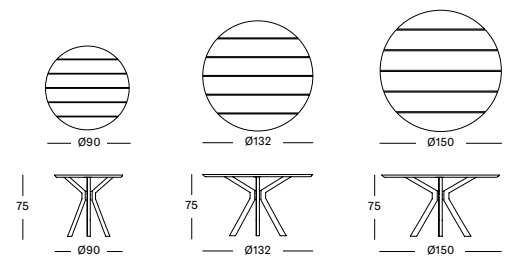



FREYA DINING ARMCHAIR

MATERIALS

untreated solid teak

CUSHION

seat 2 cm polyether foam

COLOUR



UNTREATED TEAK

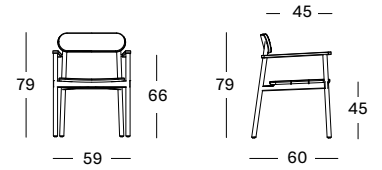

MONA DINING CHAIR TEAK

MATERIALS

polyethylene wicker seat
untreated teak base

CUSHIONS

2 cm polyether foam

COLOUR



UNTREATED TEAK
OLD LACE WICKER

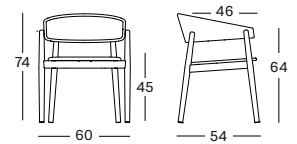

REMI DINING CHAIR TEAK BASE

MATERIALS

aluminium and polypropylene rope seat
teak base

CUSHIONS

2 cm polyether foam

COLOURS



UNTREATED TEAK
FOSSIL GREY UNTREATED TEAK
DUNE WHITE

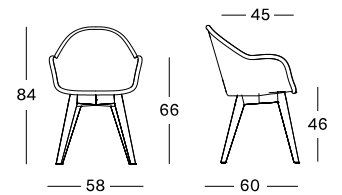

CLEO

A stylish blend of lightweight aluminium and comfortable woven rope for your outdoor spaces.

DINING ARMCHAIR - LOUNGE CHAIR - LOUNGE SOFA





CLEO LOUNGE CHAIR AND SOFA dune white
LILO COFFEE AND SIDE TABLE dune white





CLEO DINING ARMCHAIR dune white
MATTEO DINING TABLE dune white





CLEO DINING ARMCHAIR dune white
MAX DINING TABLE dune white | ceramic portland



CLEO DINING ARMCHAIR

MATERIALS

polypropylene rope
powder coated aluminium frame

CUSHIONS

2 cm polyether foam

COLOUR

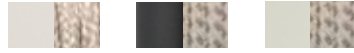

DUNE WHITE/
DUNE WHITE FOSSIL GREY/
MISTY DOTS SAGE GREEN/
MISTY DOTS

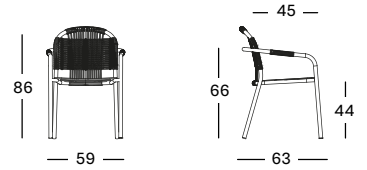

CLEO LOUNGE CHAIR

MATERIALS

polypropylene rope
powder coated aluminium frame

CUSHIONS

3 cm quick dry foam

COLOUR

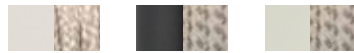

DUNE WHITE/
DUNE WHITE FOSSIL GREY/
MISTY DOTS SAGE GREEN/
MISTY DOTS

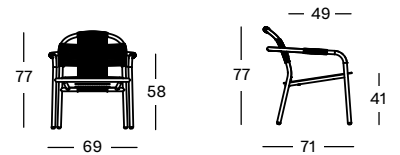

CLEO LOUNGE SOFA

MATERIALS

polypropylene rope
powder coated aluminium frame

CUSHIONS

3 cm quick dry foam

COLOUR

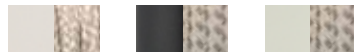

DUNE WHITE/
DUNE WHITE FOSSIL GREY/
MISTY DOTS SAGE GREEN/
MISTY DOTS

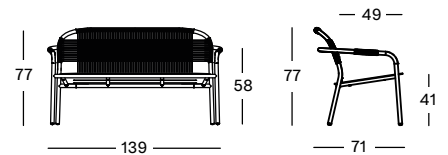

MAX DINING TABLE

MATERIALS

powder coated aluminium frame in black, fossil grey, dune white
untreated teak top, ceramic top or black hpl top (90 x 90 cm)

DIMENSIONS

90 x 90 cm
180 x 90 cm
240 x 100 cm

COLOURS

see website

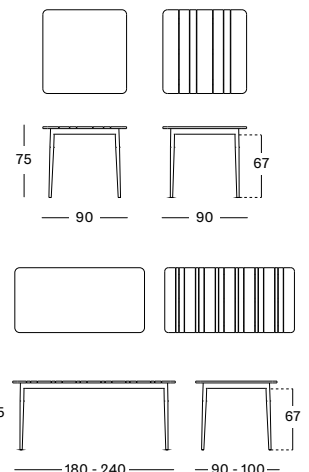

LEO

The comfortable seating of the tub chair, the laid-back shape of the sofa, and the playful weaving turn it into a real eye catcher.

LOUNGE CHAIR - LOUNGE SOFA - MODULAR SOFA
SIDE TABLE - COFFEE TABLE - DINING CHAIR - DINING TABLE





LEO LOUNGE CHAIR, MODULAR SOFA AND COFFEE TABLES





LEO MODULAR CORNER LEFT

MATERIALS

powder coated aluminium
acrylic rope

CUSHIONS

seat 12 cm quick dry foam
back polyester fibre filling + deco 1x (50x50), 1x (40x40)

COLOUR



LAVA ALUMINIUM
LAVA ROPE

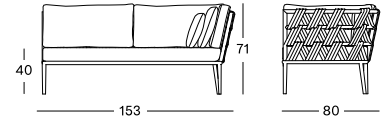

LEO MODULAR CORNER RIGHT

MATERIALS

powder coated aluminium
acrylic rope

CUSHIONS

seat 12 cm quick dry foam
back polyester fibre filling + deco 1x (50x50), 1x (40x40)

COLOUR



LAVA ALUMINIUM
LAVA ROPE

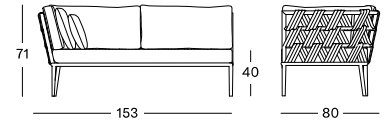

LEO MODULAR CENTER

MATERIALS

powder coated aluminium
acrylic rope

CUSHIONS

seat 12 cm quick dry foam
back polyester fibre filling

COLOUR



LAVA ALUMINIUM
LAVA ROPE

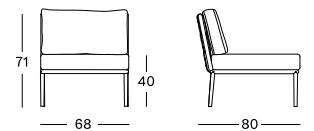

LEO MODULAR FOOTREST

MATERIALS

powder coated aluminium

CUSHION

seat 12 cm quick dry foam

COLOUR



LAVA ALUMINIUM

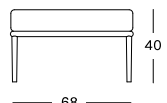



LEO LOUNGE CHAIR

MATERIALS

powder coated aluminium
acrylic rope

CUSHIONS

seat 12 cm quick dry foam
back polyester fibre filling

COLOUR



LAVA ALUMINIUM
LAVA ROPE

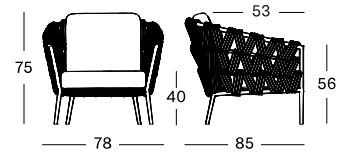

LEO LOUNGE SOFA

MATERIALS

powder coated aluminium
acrylic rope

CUSHIONS

seat 12 cm quick dry foam
back polyester fibre filling

COLOUR



LAVA ALUMINIUM
LAVA ROPE

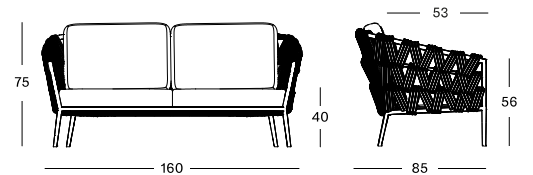

LEO COFFEE AND SIDE TABLES

MATERIALS

powder coated aluminium

DIMENSIONS

48 cm H x Ø 45 cm
32 cm H x Ø 60 cm
38 cm H x Ø 70 cm

COLOUR

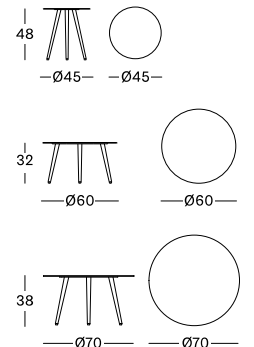

LEO MODULAR COFFEE TABLE

MATERIALS

powder coated aluminium
untreated teak

DIMENSIONS

28 cm H x 68 cm x 68 cm

COLOUR



LAVA ALUMINIUM
UNTREATED
TEAK

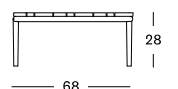





LEO DINING CHAIR

MATERIALS

powder coated aluminium
acrylic rope

CUSHIONS

seat 4 cm quick dry foam
back polyester fibre filling

COLOUR



LAVA ALUMINIUM
LAVA ROPE

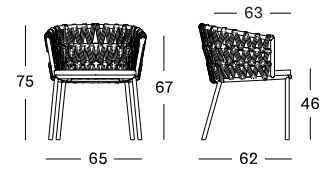

LEO DINING TABLE 90x90

MATERIALS

powder coated aluminium
untreated teak top

DIMENSIONS

90 x 90 cm

COLOUR



LAVA ALUMINIUM
UNTREATED TEAK

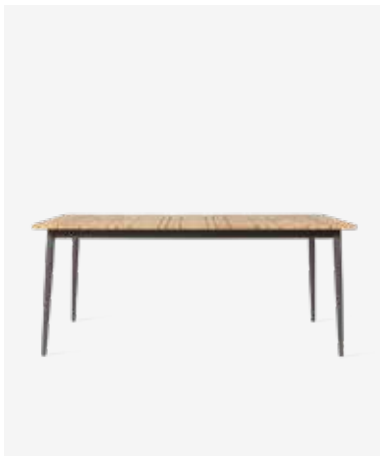
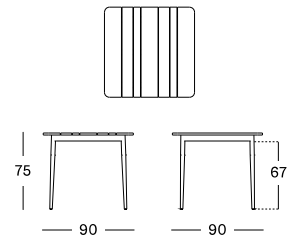

LEO DINING TABLE

MATERIALS

powder coated aluminium
untreated teak top

DIMENSIONS

180 x 90 cm
240 x 100 cm

COLOUR



LAVA ALUMINIUM
UNTREATED TEAK

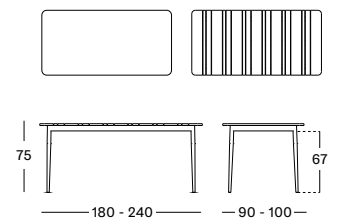

DAMIEN EDGARD LENA MATTEO

Woven wicker furniture is expertly crafted to be durable and resilient, making it perfectly suited for outdoor use in all seasons, without compromising on style or comfort.

BAR STOOL - DINING CHAIR - DINING TABLE







EDGARD DINING CHAIR TEAK BASE old lace
NOA DINING TABLE

EDGARD DINING CHAIR STEEL A BASE black
MATTEO DINING TABLE AND LIGHT MY TABLE







LENA DINING CHAIR TEAK BASE old lace



EDGARD DINING CHAIR TEAK BASE

MATERIALS

aluminium and polyethylene wicker seat
teak base

CUSHIONS

2 cm polyether foam

COLOURS



UNTREATED TEAK
OLD LACE



UNTREATED TEAK
BLACK



UNTREATED TEAK
MOCCA

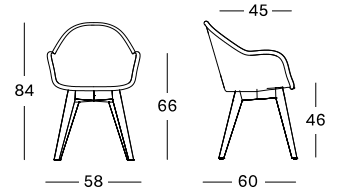

EDGARD DINING CHAIR STEEL A BASE

MATERIALS

aluminium and polyethylene wicker seat
black epoxy and powder coated steel base

CUSHIONS

2 cm polyether foam

COLOURS



BLACK
OLD LACE



BLACK
BLACK



BLACK
MOCCA

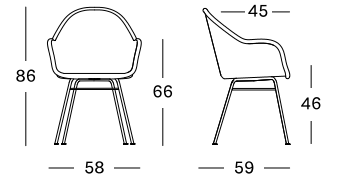

LENA DINING CHAIR TEAK BASE

MATERIALS

aluminium and polyethylene wicker seat
teak base

COLOURS



UNTREATED TEAK
OLD LACE



UNTREATED TEAK
BLACK



UNTREATED TEAK
MOCCA

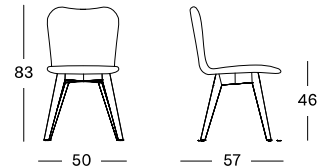



DAMIEN DINING CHAIR TEAK BASE

MATERIALS

aluminium and polyethylene wicker seat
teak base

COLOURS



UNTREATED TEAK
OLD LACE



UNTREATED TEAK
BLACK



UNTREATED TEAK
MOCCA



DAMIEN DINING CHAIR STEEL A BASE

MATERIALS

aluminium and polyethylene wicker seat
black epoxy and powder coated steel base

COLOURS



BLACK
OLD LACE



BLACK
BLACK



BLACK
MOCCA

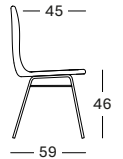
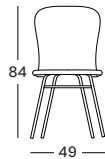

EDGARD BAR STOOL TEAK BASE

MATERIALS

aluminium and polyethylene wicker seat
teak base

COLOURS



UNTREATED TEAK
OLD LACE



UNTREATED TEAK
BLACK



UNTREATED TEAK
MOCCA

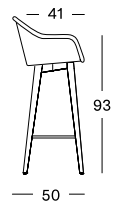
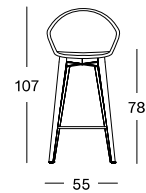

EDGARD BAR STOOL STEEL BASE

MATERIALS

aluminium and polyethylene wicker seat
black epoxy and powder coated steel base

COLOURS



BLACK
OLD LACE



BLACK
BLACK



BLACK
MOCCA

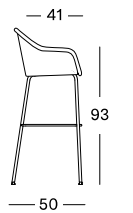
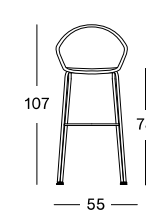



MATTEO DINING TABLE

MATERIALS

powder coated aluminium legs
untreated teak top

DIMENSIONS

215 x 100 cm
285 x 100 cm

COLOURS



BLACK ALUMINIUM
UNTREATED TEAK

DUNE WHITE ALUMINIUM
UNTREATED TEAK

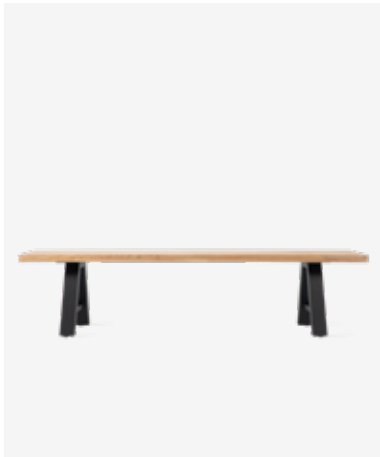
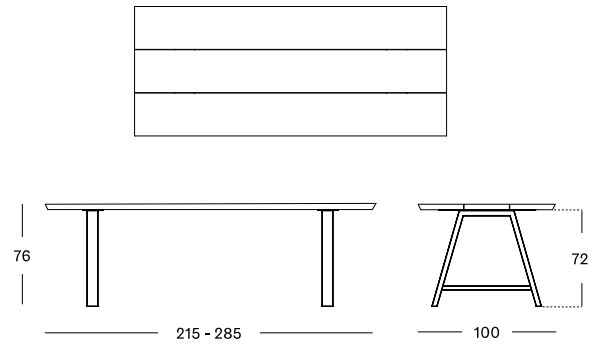

MATTEO BENCH

MATERIALS

powder coated aluminium legs
untreated teak seat

DIMENSIONS

195 x 40 cm
265 x 40 cm

COLOURS



BLACK ALUMINIUM
UNTREATED TEAK

DUNE WHITE ALUMINIUM
UNTREATED TEAK

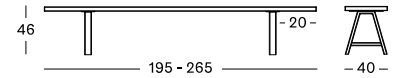

LIGHT MY TABLE

MATERIALS

black powder coated galvanized steel
leather details
9 LED lamps 2W

DIMENSIONS

adjustable 200 – 300 cm
(for table tops up to 6 cm thick)

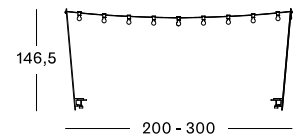

LIGHTING & ACCESSORIES

FLORENCE - INDIRA - IVO - LILO - MAYA - MORA - NOMAD - ROZY - SAYA - TESSA - TIKA







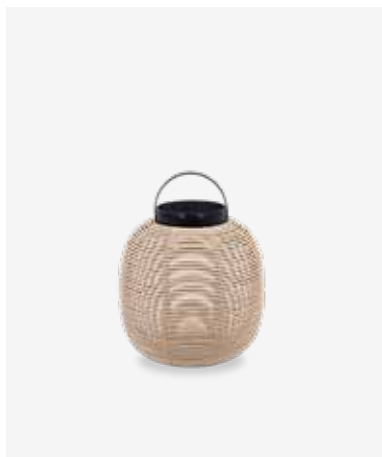

TIKA LANTERN

MATERIALS

powder coated aluminium with HDPE wicker
solar-powered LED module

DIMENSIONS

40 cm H x Ø 35 cm
59 cm H x Ø 47 cm

COLOURS



CAMEL WICKER



BLACK WICKER

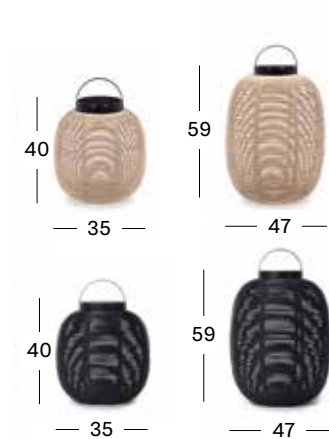

TIKA LANTERN STEEL BASE

MATERIALS

powder coated aluminium with HDPE wicker
solar-powered LED module
powder coated steel base

DIMENSIONS

59 cm H x Ø 35 cm
69 cm H x Ø 47 cm

COLOURS



CAMEL WICKER
BLACK STEEL



BLACK WICKER
BLACK STEEL

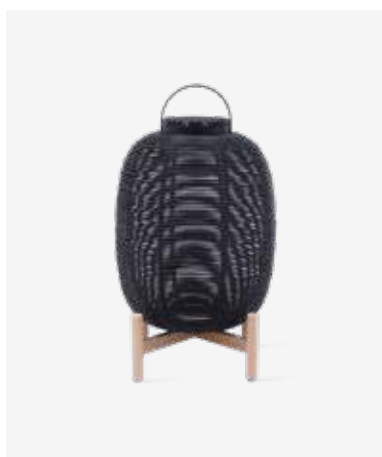

TIKA LANTERN TEAK BASE

MATERIALS

powder coated aluminium with HDPE wicker
solar-powered LED module
untreated teak base

DIMENSIONS

59 cm H x Ø 35 cm
69 cm H x Ø 47 cm

COLOURS



BLACK WICKER
UNTREATED TEAK

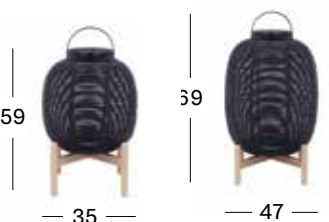



MAYA LAMP SMALL

MATERIALS

repurposed teak slats
casted aluminium frame
solar-powered LED module

DIMENSIONS

34 cm H x Ø 27 cm

COLOURS



UNTREATED TEAK
BLACK ALUMINIUM

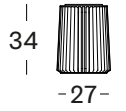

MAYA LAMP LARGE

MATERIALS

repurposed teak slats
casted aluminium frame
solar-powered LED module

DIMENSIONS

48 cm H x Ø 28 cm

COLOURS



UNTREATED TEAK
BLACK ALUMINIUM

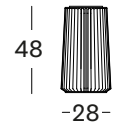



MORA LAMP WITH HANDLE

MATERIALS

powder coated steel
polypropylene rope
solar-powered LED module

DIMENSIONS

54 cm H x Ø 26 cm

COLOUR



FOSSIL GREY ROPE
BLACK STEEL

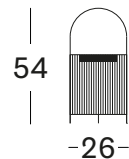

MORA LAMP MEDIUM

MATERIALS

powder coated steel
polypropylene rope
solar-powered LED module

DIMENSIONS

42 cm H x Ø 54 cm

COLOUR



FOSSIL GREY ROPE
BLACK STEEL

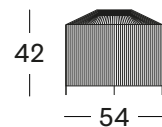

MORA LAMP LARGE

MATERIALS

powder coated steel
polypropylene rope
solar-powered LED module

DIMENSIONS

61 cm H x Ø 40 cm

COLOUR



FOSSIL GREY ROPE
BLACK STEEL

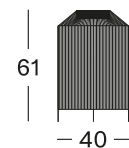







INDIRA OUTDOOR CUSHION

MATERIALS

deco cushion
filled with polyester fibre

DIMENSIONS

30 cm x 50 cm
40 cm x 40 cm
45 cm x 50 cm
50 cm x 50 cm
60 cm x 60 cm

FABRICS

see page 204

COLOURS



SAFFRON



BURNT
ORANGE



EMERALD



FEZ OCHRE



FEZ RUST



FEZ GREEN



RABAT OCHRE



RABAT RUST



RABAT GREEN



INDIRA FRINGE OUTDOOR CUSHION

MATERIALS

deco cushion with short fringe
filled with polyester fibre

DIMENSIONS

40 cm x 40 cm
50 cm x 50 cm

FABRICS

see page 204

COLOURS



SAFFRON



BURNT
ORANGE



EMERALD



FEZ OCHRE



FEZ RUST



FEZ GREEN



RABAT OCHRE



RABAT RUST



RABAT GREEN



INDIRA LONG FRINGE OUTDOOR CUSHION

MATERIALS

deco cushion with long fringe
filled with polyester fibre

DIMENSIONS

35 cm x 50 cm
45 cm x 50 cm

FABRICS

see page 204

COLOURS



SAFFRON



BURNT
ORANGE



EMERALD



FEZ OCHRE



FEZ RUST



FEZ GREEN

RUGS



TESSA ROUND RUG

MATERIALS

polypropylene

DIMENSIONS

Ø 160 cm

Ø 200 cm

COLOURS



SAND

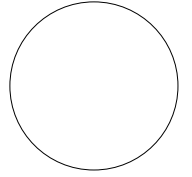

160-200



TESSA RECTANGULAR RUG

MATERIALS

polypropylene

DIMENSIONS

170 cm x 240 cm

200 cm x 300 cm

250 cm x 350 cm

COLOURS



SAND

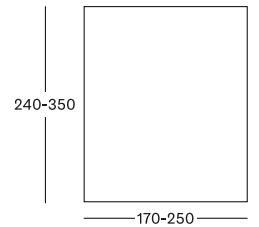

240-350

170-250

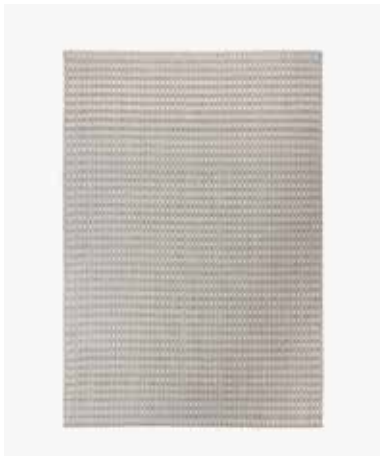

NOMAD RUG

MATERIALS

polypropylene and PVC

DIMENSIONS

170 cm x 240 cm

200 cm x 300 cm

250 cm x 350 cm

COLOURS



SAND



GREY

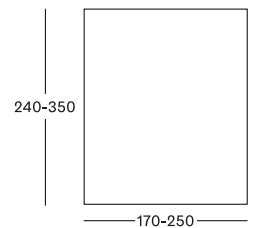

240-350

170-250







SAYA PLANT POT ROUND

MATERIALS

Terracotta

DIMENSIONS

33 cm H x Ø 35 cm

45 cm H x Ø 49 cm

COLOURS



TERRACOTTA

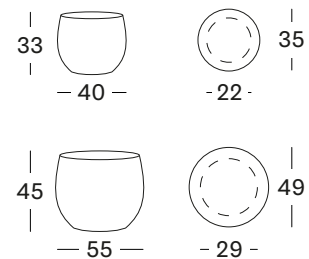

SAYA PLANT POT OVAL

MATERIALS

Terracotta

DIMENSIONS

50 cm H x Ø 45 cm

63 cm H x Ø 55 cm

COLOURS



TERRACOTTA

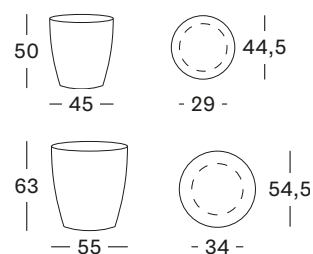

SAYA PLANT POT CONIC

MATERIALS

Terracotta

DIMENSIONS

43 cm H x Ø 40 cm

54 cm H x Ø 50 cm

COLOURS



TERRACOTTA

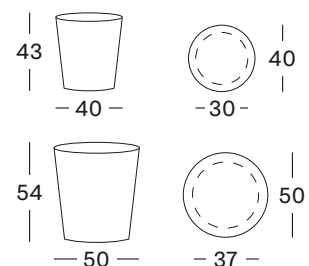

FLORENCE PARASOL ROUND canvas
WICKED LOUNGE SOFA 3S AND COFFEE TABLE terracotta | natural
TESSA RECTANGULAR RUG sand





PARASOLS

FLORENCE COLOURS

FRAME



EUCALYPTUS
W010

CANOPY FABRIC IN STOCK

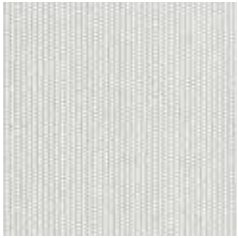

CANVAS
S0606

CANOPY FABRIC ON DEMAND



LIN
S1212



LONDON STONE
S0808

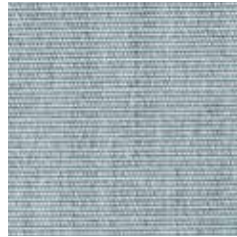

MINERAL BLUE
S1010

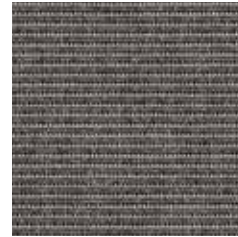

DARK SMOKE
S0909



BLUSH
S2929



BLACK
S1515



AMBER
S3838



OLIVE GREEN
S2727



CARBON BEIGE
S2828

BASE

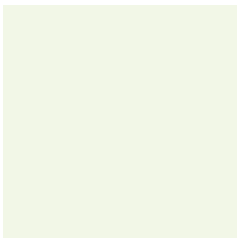

CHAMPAGNE
M011



FLORENCE PARASOL 250X250

MATERIALS

frame in clear varnished eucalyptus
 canopy in fabric
 powder coated steel plate with zinc plating
 black swivel castors with lock

DIMENSIONS

263 cm H x 250 cm x 250 cm

COLOURS

see page 174

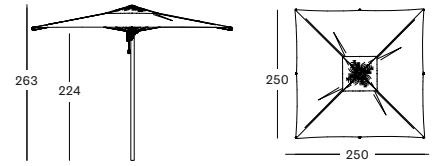

FLORENCE PARASOL 300X300

MATERIALS

frame in clear varnished eucalyptus
 canopy in fabric
 powder coated steel plate with zinc plating
 black swivel castors with lock

DIMENSIONS

261 cm H x 300 cm x 300 cm

COLOURS

see page 174

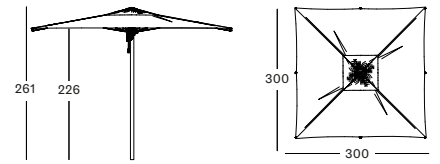

FLORENCE PARASOL DIA 350

MATERIALS

frame in clear varnished eucalyptus
 canopy in fabric
 powder coated steel plate with zinc plating
 black swivel castors with lock

DIMENSIONS

266 cm H x 350 cm x 350 cm

COLOURS

see page 174

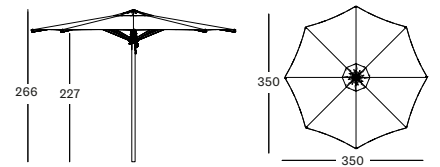

COFFEE & SIDE TABLES



IVO SIDE TABLE DIA 44

MATERIALS

powder coated aluminium
HDPE wicker
hpl

DIMENSIONS

45 cm H x Ø 44 cm

COLOURS



BLACK WICKER
BLACK HPL



IVO COFFEE TABLE DIA 77

MATERIALS

powder coated aluminium
HDPE wicker
hpl

DIMENSIONS

37 cm H x Ø 77 cm

COLOURS



BLACK WICKER
BLACK HPL



ROZY SIDE TABLE

MATERIALS

black epoxy and powder coated steel
black hpl

DIMENSIONS

50 x 49 x 42 cm

COLOURS



BLACK HPL

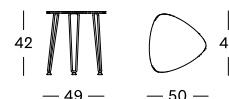

ROZY COFFEE TABLE

MATERIALS

black epoxy and powder coated steel
black hpl

DIMENSIONS

99 x 114 x 72 cm

COLOURS



BLACK HPL

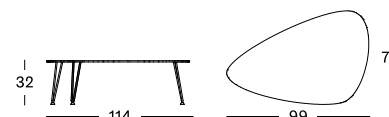

LILO SIDE TABLE

MATERIALS

powder coated aluminium

DIMENSIONS

44 cm H x Ø 45 cm

COLOURS

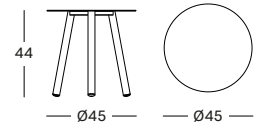

LILO COFFEE TABLE

MATERIALS

powder coated aluminium

DIMENSIONS

36 cm H x Ø 60 cm
30 cm H x Ø 68 cm

COLOURS

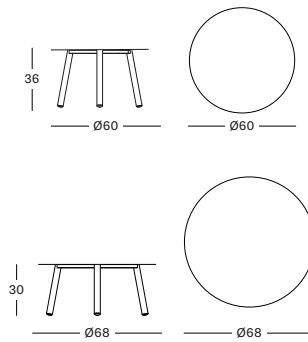

SAFI

Safi stands for timeless outdoor pleasure. The handwoven furniture gives your terrace a royal comfort and adapts naturally to each environment.

LOUNGE CHAIR - LOUNGE SOFA - SIDE TABLE - SUNLOUNGER - DINING CHAIR - DINING TABLE





SAFI LOUNGE SOFA 2S, LOUNGE SOFA 3S AND LOUNGE CHAIR old lace





LEFT PAGE: SAFI SUNLOUNGER WITH ARMS old lace
RIGHT PAGE: SAFI DINING CHAIR AND DINING TABLE old lace





SAFI DINING CHAIR

MATERIALS

powder coated aluminium frame
polyethylene wicker

CUSHION

4 cm polyether foam

COLOUR



OLD LACE

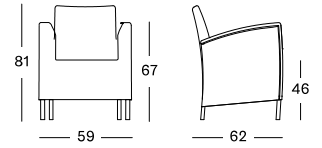

SAFI DINING TABLE DIA 120

MATERIALS

powder coated aluminium frame
polyethylene wicker
glass (optional)

DIMENSIONS

75 cm H x Ø 120 cm

COLOUR



OLD LACE

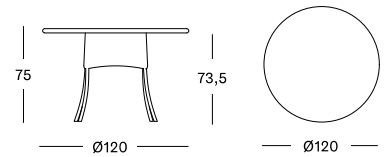

SAFI SUNLOUNGER

MATERIALS

powder coated aluminium frame
polyethylene wicker

CUSHION

3 cm polyether foam

COLOUR



OLD LACE

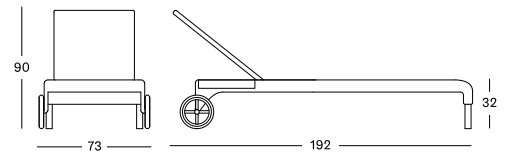

SAFI SUNLOUNGER WITH ARMS

MATERIALS

powder coated aluminium frame
polyethylene wicker

CUSHION

3 cm polyether foam

COLOUR



OLD LACE

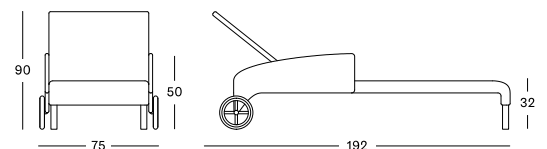



SAFI LOUNGE CHAIR

MATERIALS

powder coated aluminium frame
polyethylene wicker

CUSHION

seat 12 cm quick dry foam
back polyester fibre

COLOUR



OLD LACE

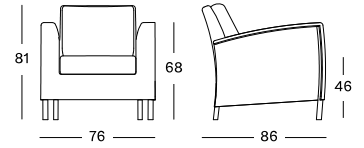

SAFI LOUNGE SOFA 2S

MATERIALS

powder coated aluminium frame
polyethylene wicker

CUSHION

seat 12 cm quick dry foam
back polyester fibre

COLOUR



OLD LACE

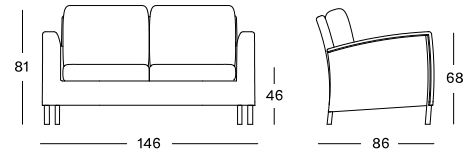

SAFI LOUNGE SOFA 3S

MATERIALS

powder coated aluminium frame
polyethylene wicker

CUSHION

seat 12 cm quick dry foam
back polyester fibre

COLOUR



OLD LACE

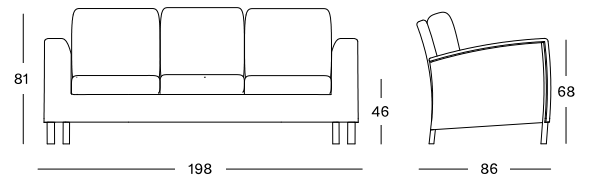

SAFI SIDE TABLE

MATERIALS

powder coated aluminium frame
polyethylene wicker
glass (optional)

DIMENSIONS

60 x 60 cm

COLOUR



OLD LACE

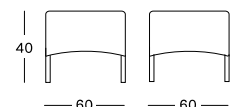



KENZO DINING CHAIR old lace



MIA DINING CHAIR

MATERIALS

aluminium frame
polyethylene wicker

CUSHIONS

4 cm polyether foam

COLOURS



OLD LACE

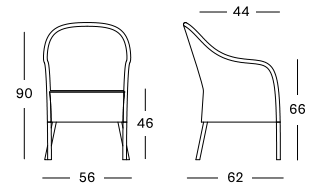

KENZO DINING CHAIR

MATERIALS

aluminium frame
polyethylene wicker

CUSHIONS

4 cm polyether foam

COLOURS



OLD LACE

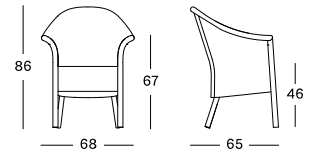

OUTDOOR LLOYD LOOM

Lloyd Loom weave is a unique material made of steel and paper. The strong and flexible loom is coated with an outdoor lacquer for outdoor use.

LOUNGE CHAIR - LOUNGE SOFA - FOOTREST - SIDE TABLE - COFFEE TABLE - SUNLOUNGER - DINING CHAIR - DINING TABLE





MONTE CARLO DINING CHAIR dusty green







LEFT PAGE: DOVILE DINING CHAIR pure white
RIGHT PAGE: NICE DINING CHAIR dusty green
© Kit Kemp Design Studio for Number 16



DOVILE DINING CHAIR

MATERIALS

powder coated aluminium frame
 outdoor treated Lloyd Loom weave

CUSHION

seat 4 cm polyether foam

LOOM COLOURS

see page 197

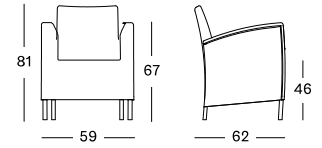

NIMES TABLE DIA 110 | 130

MATERIALS

powder coated aluminium frame
 outdoor treated Lloyd Loom weave
 glass (optional)

DIMENSIONS

76 cm H x Ø 110 cm
 76 cm H x Ø 130 cm

LOOM COLOURS

see page 197

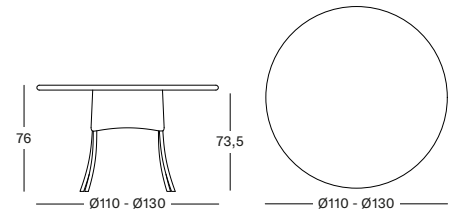

DOVILE COFFEE TABLE

MATERIALS

powder coated aluminium frame
 outdoor treated Lloyd Loom weave
 glass (optional)

DIMENSIONS

45 cm H x 60 cm x 106 cm

LOOM COLOURS

see page 197

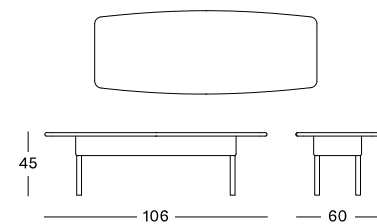

DOVILE SIDE TABLE

MATERIALS

powder coated aluminium
 outdoor treated Lloyd Loom weave
 glass (optional)

DIMENSIONS

40 cm H x 60 cm x 60 cm

LOOM COLOURS

see page 197

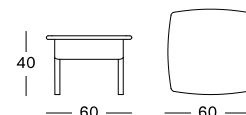



DOVILE LOUNGE CHAIR

MATERIALS

powder coated aluminium frame
outdoor treated Lloyd Loom weave

CUSHIONS

seat 12 cm high resilience foam
back polyester fibre

LOOM COLOURS

see page 197

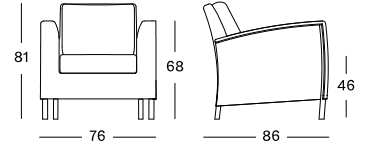

DOVILE LOUNGE SOFA 2S

MATERIALS

powder coated aluminium frame
outdoor treated Lloyd Loom weave

CUSHIONS

seat 12 cm high resilience foam
back polyester fibre

LOOM COLOURS

see page 197

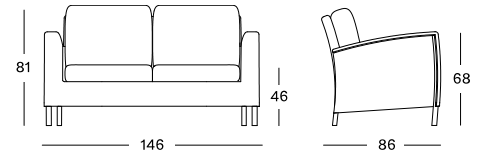

DOVILE LOUNGE SOFA 3S

MATERIALS

powder coated aluminium frame
outdoor treated Lloyd Loom weave

CUSHIONS

seat 12 cm high resilience foam
back polyester fibre

LOOM COLOURS

see page 197

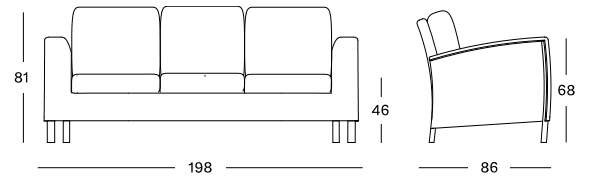



DOVILE SUNLOUNGER WITH ARMS

MATERIALS

powder coated aluminium frame
outdoor treated Lloyd Loom weave

CUSHION

seat 3 cm polyether foam

LOOM COLOURS

see page 197

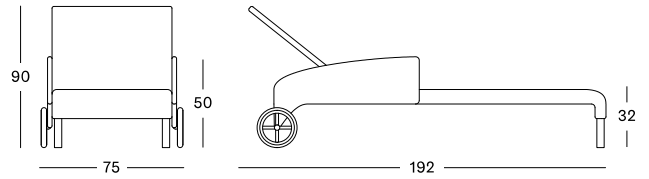

NICE DINING CHAIR

MATERIALS

powder coated aluminium frame
outdoor treated Lloyd Loom weave

CUSHION

seat 4 cm polyether foam

LOOM COLOURS

see page 197

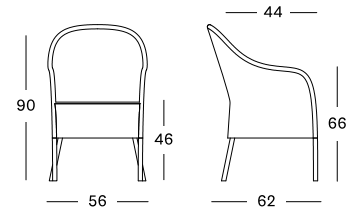

MONTE CARLO DINING CHAIR

MATERIALS

powder coated aluminium frame
outdoor treated Lloyd Loom weave

CUSHION

seat 4 cm polyether foam

LOOM COLOURS

see page 197

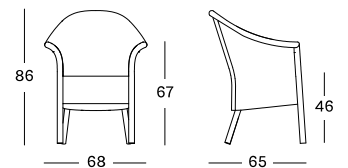

AVIGNON SIDE TABLE

MATERIALS

powder coated aluminium frame
outdoor treated Lloyd Loom weave
glass (optional)

DIMENSIONS

60 cm H x Ø 60 cm

LOOM COLOURS

see page 197

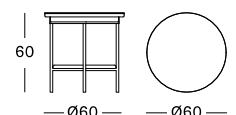

SOLID COLOURS

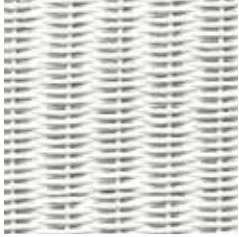

PURE WHITE
P024



SNOW
P020

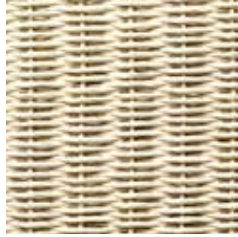

BROKEN WHITE
P026



PEBBLE
P025

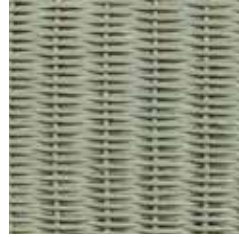

DUSTY GREEN
P050

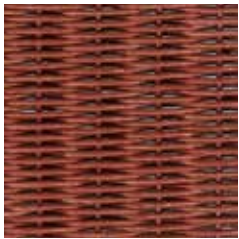

TERRACOTTA
P035

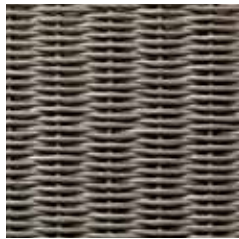

QUARTZ GREY
P086

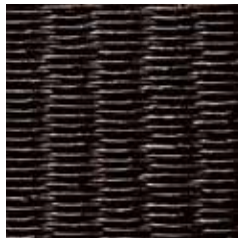

BLACK
P080

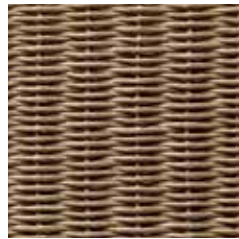

TAUPE
P084

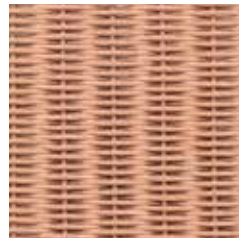

DUSTY CORAL
P034

METALLIC FINISH

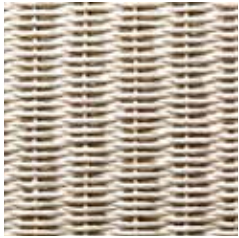

SPARKLE
P033

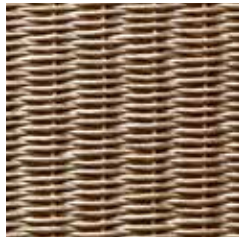

NACRÉ
P023

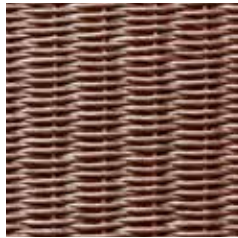

COPPER
P079

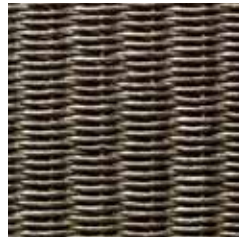

OYSTER
P036

All colours shown here are as close to the actual colours as the printing process allows.
Swatches can be supplied on request.

CUSHIONS & FABRICS

DECO CUSHIONS



DIMENSIONS

60 x 60 cm

FABRICS

see page 202 - 204



DIMENSIONS

50 x 50 cm

FABRICS

see page 202 - 204



DIMENSIONS

45 x 40 cm

FABRICS

see page 202 - 204



DIMENSIONS

40 x 40 cm

FABRICS

see page 202 - 204



DIMENSIONS

35 x 50 cm

FABRICS

see page 202 - 204

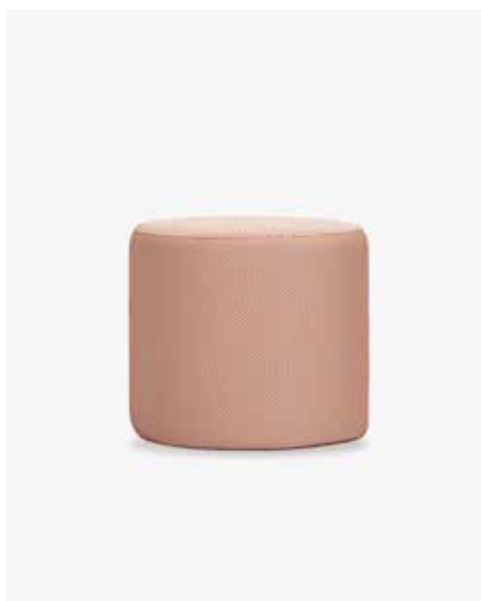

OLAF DIA 50

MATERIALS

breathable polyester
polystyrene beads

DIMENSIONS

44 cm H x Ø 50 cm

FABRICS

see page 202 - 204

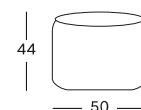

OLAF DIA 80

MATERIALS

breathable polyester
polystyrene beads

DIMENSIONS

40 cm H x Ø 80 cm

FABRICS

see page 202 - 204

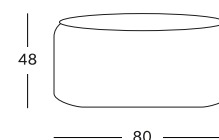

OTTO

MATERIALS

breathable polyester
polystyrene beads

DIMENSIONS

42 cm H x Ø 52 cm

COLOURS



TAUPE



CHARCOAL



MOSS



TERRACOTTA

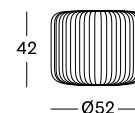

OUTDOOR FABRICS

CAT. B CUSHION FABRICS

Item codes starting with CB or QB



CANVAS S0606
100% SOLUTION DYED ACRYLIC



LIN S1212
100% SOLUTION DYED ACRYLIC



LONDON STONE S0808
100% SOLUTION DYED ACRYLIC

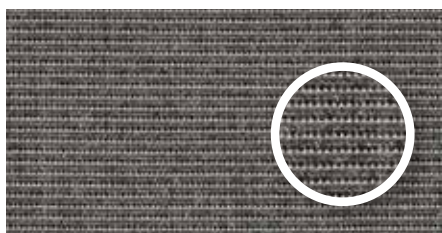

DARK SMOKE S0909
100% SOLUTION DYED ACRYLIC



MINERAL BLUE S1010
100% SOLUTION DYED ACRYLIC



BLUSH S2929
100% SOLUTION DYED ACRYLIC



BLACK S1515
100% SOLUTION DYED ACRYLIC



OLIVE GREEN S2727
100% SOLUTION DYED ACRYLIC



CARBON BEIGE S2828
100% SOLUTION DYED ACRYLIC



AMBER S3838
100% SOLUTION DYED ACRYLIC

CAT. C CUSHION FABRICS

Item codes starting with CC or QC



SAVANE COCONUT S2222
100% SOLUTION DYED ACRYLIC

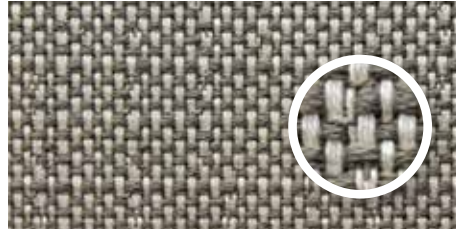

ZINC S2121
100% SOLUTION DYED ACRYLIC

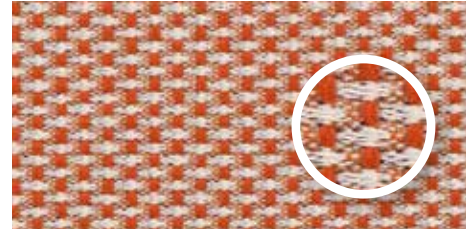

CORAL P0404
57% POLYOLEFIN / 43% POLYESTER

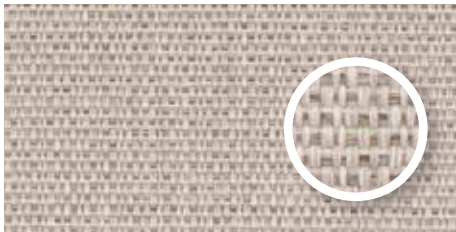

ALMOND P0303
100% POLYPROPYLENE

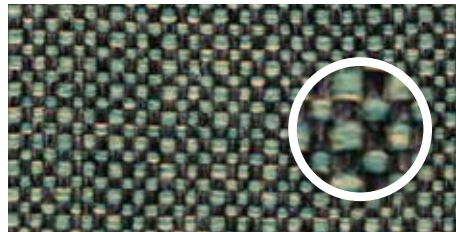

PINE GREEN M0202
100% POLYPROPYLENE



FIG GREEN M0303
100% POLYPROPYLENE

CAT. G CUSHION FABRICS

Item codes starting with CG or QG



LIME WHITE BOUCLÉ M0101
100% POLYPROPYLENE

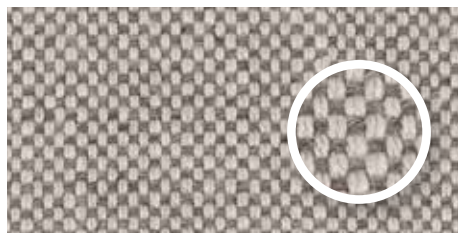

STONE T0202
100% SOLUTION DYED ACRYLIC



NEGRONI P0808
100% POLYPROPYLENE

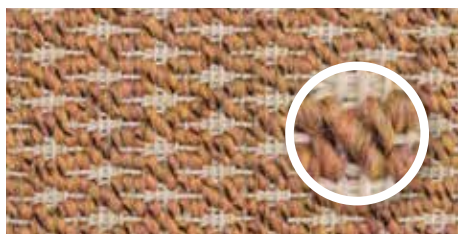

SIENNA M0505
100% POLYPROPYLENE

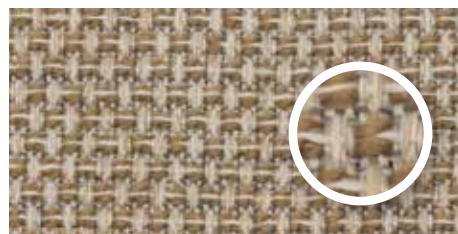

SANTAL M0606
100% POLYPROPYLENE



SAFFRON M1313
100% POLYPROPYLENE

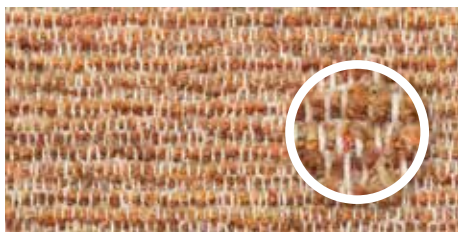

BURNT ORANGE M1414
100% POLYPROPYLENE

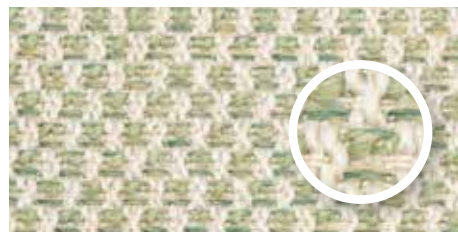

EMERALD M1515
100% POLYPROPYLENE



FEZ OCHRE M1010
100% POLYPROPYLENE



FEZ RUST M1111
100% POLYPROPYLENE



FEZ GREEN M1212
100% POLYPROPYLENE



RABAT OCHRE M0707
100% POLYPROPYLENE



RABAT RUST M0808
100% POLYPROPYLENE

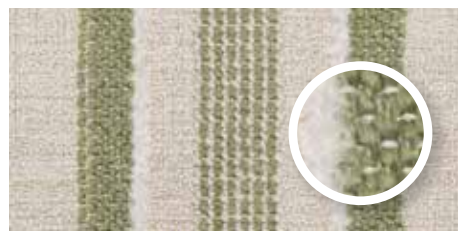

RABAT GREEN M0909
100% POLYPROPYLENE



PRODUCT OVERVIEW

DINING CHAIRS - COUNTER & BAR STOOLS - LOUNGE CHAIRS - SOFAS - FOOTRESTS
SUNLOUNGERS - DINING TABLES - COFFEE TABLES - SIDE TABLES - ACCESSORIES

DINING CHAIRS



FIKA DINING ARMCHAIR
P 23



FRIDA DINING CHAIR
P 59



ODA DINING CHAIR
P 48



AKARI DINING CHAIR
P 40



MONA DINING CHAIR
P 131



EDGARD DINING CHAIR
P 155



RIBBON DINING ARMCHAIR
P 11



SWEEP DINING CHAIR
P 11



KODO DINING CHAIR
P 70



WICKED DINING CHAIR
P 32



ROXANNE DINING CHAIR
P 93



ROXY DINING CHAIR
P 93

DINING CHAIRS



LOOP DINING CHAIR
P 112



CLEO DINING ARMCHAIR
P 139



LEO DINING CHAIR
P 147



DAVID DINING ARMCHAIR
P 120



LUCY DINING CHAIR
P 101



LUCY DINING ARMCHAIR
P 101



REMI DINING CHAIR
P 131



FREYA DINING ARMCHAIR
P 131



LENA DINING CHAIR
P 155



DAMIEN DINING CHAIR
P 156



MIA DINING CHAIR SYNTHETIC
P 187



KENZO DINING CHAIR SYNTHETIC
P 187



SAFI DINING CHAIR SYNTHETIC
P 184

DINING CHAIRS



NICE DINING CHAIR LLOYD LOOM
P 196



MONTE CARLO DINING CHAIR LLOYD LOOM
P 196



DOVILE DINING CHAIR LLOYD LOOM
P 194



MATTEO BENCH
P 157

BAR STOOLS



KODO BAR STOOL
P 77



EDGARD BAR STOOL TEAK BASE
P 156



EDGARD BAR STOOL STEEL BASE
P 156



ELKO DINING TABLE
P 23



MISTRAL DINING TABLE
P 12



NOA DINING TABLE
P 59



KODO DINING TABLE
P 71



LEO DINING TABLE
P 147



MAX DINING TABLE
P 139

DINING TABLES



VOLTA DINING TABLE
P 130



DAVID DINING TABLE
P 120



MATTEO DINING TABLE
P 157



WICKED DINING TABLE
P 32



SANDRO DINING TABLE RECTANGULAR
P 41



SANDRO DINING TABLE ROUND
P 41



SANDRO BAR TABLE
P 41



RONDA BISTRO TABLE
P 92



QUADRO BISTRO TABLE
P 92



SPHERA BISTRO TABLE
P 92



SAM DINING TABLE
P 130



SAFI DINING TABLE
P 184



NIMES DINING TABLE
P 194

LOUNGE CHAIRS



ODA LOUNGE CHAIR
P 48



TOMUS LOUNGE CHAIR
P 16



ROY LAZY CHAIR
P 93



ROY COCOON
P 93



AKARI LOUNGE CHAIR
P 40



WICKED LOUNGE CHAIR
P 33



RIBBON LOUNGE CHAIR
P 11



FRIDA LOUNGE CHAIR
P 59



LENTO LOUNGE CHAIR
P 83



KODO LOUNGE CHAIR
P 70



KODO ROCKING CHAIR
P 71



KODO COCOON
P 70



LOUNGE CHAIRS



DAVID LOUNGE CHAIR
P 121



LEO LOUNGE CHAIR
P 145



LUCY LAZY ARMCHAIR
P 101



LOOP LOUNGE CHAIR
P 112



DOVILE LOUNGE CHAIR LLOYD LOOM
P 195



SAFI LOUNGE CHAIR SYNTHETIC
P 185



CLEO LOUNGE CHAIR
P 139



FOOTRESTS AND POUFFES



OTTO POUFFE
P 201



OLAF POUFFE
P 201



RIBBON FOOTREST
P 11



KODO FOOTREST
P 70



LOOP FOOTREST
P 112



LUCY FOOTREST
P 101

SOFAS



KODO DEEP SOFA
P 74



KODO DAYBED
P 71



KODO LOUNGE SOFA
P 71



DAVID LOUNGE SOFA 2S
P 121



DAVID LOUNGE SOFA 3S
P 121



ODA LOUNGE SOFA 2,5S
P 48



ODA LOUNGE SOFA 3S
P 48



AKARI LOUNGE SOFA 2,5S
P 40



AKARI LOUNGE SOFA 3S
P 40



LENTO LOUNGE SOFA 2,5S
P 83



LENTO LOUNGE SOFA 3S
P 83

SOFAS



LEO LOUNGE SOFA
P 145



WICKED LOUNGE SOFA 2S/3S
P 33



DOVILE LOUNGE SOFA 2S/3S LLOYD LOOM
P 195



SAFI LOUNGE SOFA 2S/3S SYNTHETIC
P 185



CLEO LOUNGE SOFA
P 139



LOOP LOUNGE SOFA
P 112



ODA SUNLOUNGER
P 49



KODO SUNLOUNGER
P 74



WICKED SUNLOUNGER
P 33



LUCY SUNLOUNGER
P 100



SAFI SUNLOUNGER SYNTHETIC
P 184



SAFI SUNLOUNGER WITH ARMS SYNTHETIC
P 184



**DOVILE SUNLOUNGER WITH ARMS
LLOYD LOOM**
P 196



DAVID SUNLOUNGER
P 121



LOOP SUNLOUNGER
P 113

MODULAR SOFAS



KODO MODULAR SET
P 72



KODO MODULAR 2 SEATER RIGHT
P 72



KODO MODULAR CORNER
P 73



KODO MODULAR 2 SEATER LEFT
P 73



KODO MODULAR 1 SEATER RIGHT
P 72



KODO MODULAR CENTER
P 72



KODO MODULAR COFFEE TABLE
P 74



KODO MODULAR 1 SEATER LEFT
P 73



KODO MODULAR CHAISE LONGUE RIGHT
P 72



KODO MODULAR OTTOMAN
P 74



KODO MODULAR CHAISE LONGUE LEFT
P 73

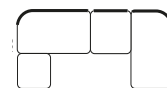
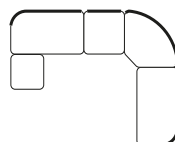
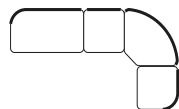
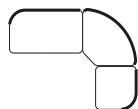
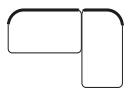



LENTO MODULAR SET
P 84



LENTO MODULAR CORNER RIGHT
P 84



LENTO MODULAR CORNER LEFT
P 84



LENTO CHAISE LONGUE LEFT
P 85



LENTO CHAISE LONGUE RIGHT
P 85



LENTO MODULAR OTTOMAN
P 85



LENTO MODULAR CONNECTING SIDE TABLE
P 84

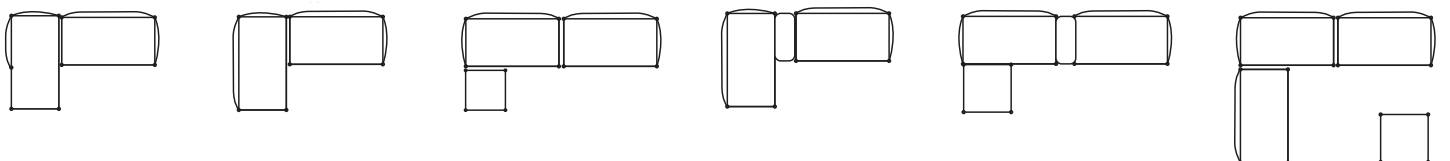



LUCY MODULAR SET
P 103



LUCY MODULAR CORNER
P 103



LUCY MODULAR CENTER
P 103



LUCY MODULAR OTTOMAN
P 103



LUCY MODULAR COFFEE TABLE
P 103

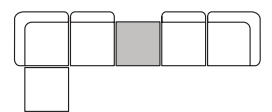
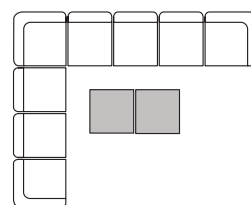
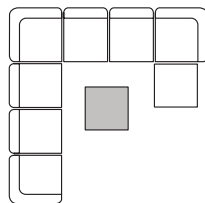
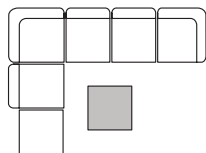
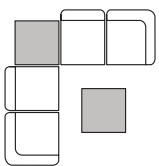



LEO MODULAR SET
P 144



LEO MODULAR CORNER RIGHT
P 144



LEO MODULAR CORNER LEFT
P 144



LEO MODULAR CENTER
P 144



LEO MODULAR COFFEE TABLE
P 145



LEO MODULAR FOOTREST
P 144

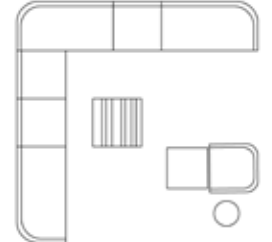
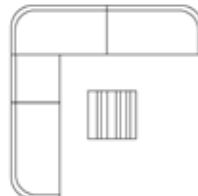
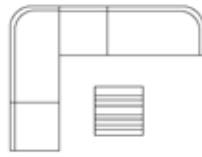

COFFEE AND SIDE TABLES



ODA COFFEE AND SIDE TABLES
P 51



IVO COFFEE AND SIDE TABLE
P 176



WICKED COFFEE TABLE & SIDE TABLE
P 32



LENTO COFFEE & SIDE TABLES
P 83



DAVID ROUND COFFEE TABLE & SIDE TABLE
P 120



LILO COFFEE AND SIDE TABLES
P 113



ANTON COFFEE AND SIDE TABLES
P 59



KODO COFFEE TABLE & SIDE TABLE
P 75



KODO ROUND COFFEE TABLES & SIDE TABLE
P 75



DAVID COFFEE TABLE & SIDE TABLE
P 120



DAVID COFFEE TABLE 120 X 120
P 120

COFFEE AND SIDE TABLES



LEO COFFEE & SIDE TABLES
P 145



LOOP SIDE TABLE
P 113



ROZY COFFEE & SIDE TABLE
P 176



LUCY SIDE TABLE
P 100



AVIGNON SIDE TABLE LLOYD LOOM
P 196



SAFI SIDE TABLE SYNTHETIC
P 185



DOVILE COFFEE & SIDE TABLE
P 194



MAYA LAMP
P 163



MORA LAMP
P 164



TIKA LAMP
P 162



LIGHT MY TABLE
P 157

ACCESSORIES



FLORENCE PARASOL
P 175



SAYA PLANT POT
P 171



NOMAD RUG
P 168

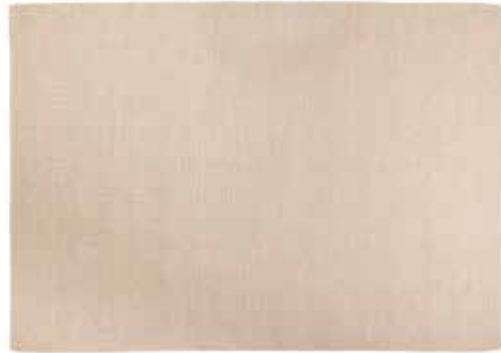

TESSA RECTANGULAR RUG
P 168



TESSA ROUND RUG
P 168



INDIRA DECO CUSHION
P 167



INDIRA FRINGE DECO CUSHION
P 167



INDIRA LONG FRINGE DECO CUSHION
P 167

Vincent Sheppard HQ

Industriepark 5
8587 Spiere - Belgium
+32 56 46 11 11
info@vincentsheppard.com

Vincent Sheppard showroom

Doornikserijksweg 193A
8510 Bellegem - Belgium

On appointment only

Vincent Sheppard USA

730 Taylor Avenue
High Point, NC, 27260 - USA
usa@vincentsheppard.com

www.vincentsheppard.com



VINCENT SHEPPARD

OUTDOOR COLLECTION 2026-2027