



G A N  
D I A  
B L A  
S C O

Gandia Blasco Group  
1941

# Contract Catalogue

## OUTDOOR FURNITURE

GANDIABLASCO **d|abla**



## PRODUCT MAP

### CHAISE LOUNGE. TUMBONA



### SIDE TABLES. MESA TUMBONAS



### DECKCHAIR. HAMACA

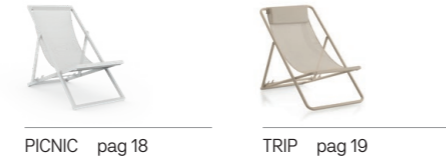

### BED. CAMA



### OUTDOOR SPACES

### SOFA. SOFÁ



### SECTIONAL. MODULAR



### CLUB ARMCHAIRS. BUTACAS



### COFFEE TABLE. MESA BAJA



### DINING CHAIR. SILLA



### STOOL. TABURETE



### DINING TABLE. MESA ALTA



### BAR TABLE. MESA BAR



### ACCESSORIES. COMPLEMENTOS



CHAISE LOUNGE  
TUMBONA

SIDE TABLES  
MESA TUMBONAS

BED  
CAMA

OUTDOOR SPACES  
ESPACIOS EXTERIORES





Rotomoulded 100% recyclable polyethylene.  
 Polietileno 100 % reciclable mediante moldeo rotacional.

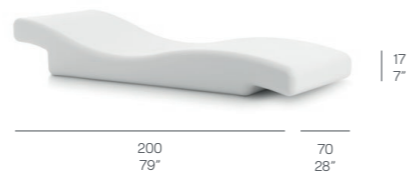

Powder-coated aluminium. Self-supporting fabrics (Batyline®, Moaré and Grid). Polyurethane foam rubber and polyester fibre with water-repellent fabric. Stackable.  
 Aluminio termolacado. Telas autoportante (Batyline®, Moaré y Grid). Gomaespuma de poliuretano reutilizable y fibra de poliéster con tejido hidrófugo. Apilable.



CHAISE LOUNGE. TUMBONA



CHAISE LOUNGE WITH ARMS. TUMBONA CON BRAZOS

STACK Borja García

CHAISE LOUNGE. TUMBONA



Powder-coated aluminium. Self-supporting fabrics (Batyline®, Moaré and Grid). Polyurethane foam rubber and polyester fibre with water-repellent fabric. Stackable.  
Aluminio termolacado. Telas autoportante (Batyline®, Moaré y Grid). Gomaespuma de poliuretano reutilizable y fibra de poliéster con tejido hidrófugo. Apilable.



TIMELESS José A. Gandía-Blasco Canales. Borja García CHAISE LOUNGE. TUMBONA



Powder-coated aluminium. Polyurethane foam rubber covered with water-repellent fabric.  
Aluminio soldado termolacado. Gomaespuma de poliuretano recubierta con tejido hidrófugo.



FLAT TEXTIL Mario Ruiz

HIGH CHAISE LOUNGE. TUMBONA

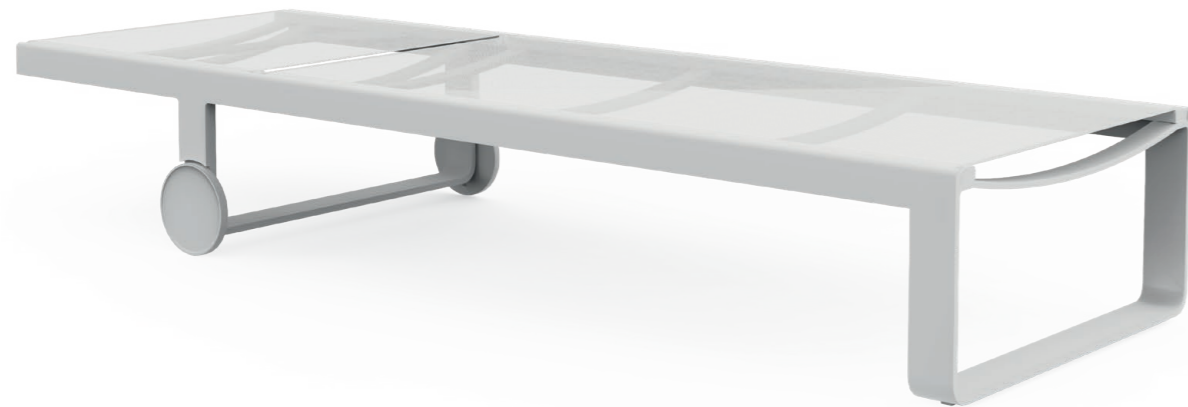

Powder-coated aluminium. Self-supporting fabrics (Batyline®, Moaré and Grid).  
Aluminio termolacado. Telas autoportante (Batyline®, Moaré y Grid).

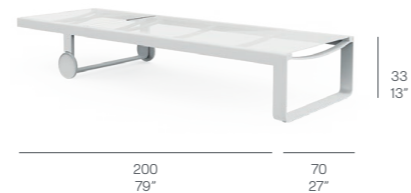

ISLABLANCA José A. Gandía-Blasco Canales

CHAISE LOUNGE. TUMBONA



Powder-coated aluminium. Polyurethane foam rubber and polyester fibre with water-repellent fabric.  
Removable technical upholstery for outdoor use.  
Aluminio termolacado. Gomaespuma de poliuretano reutilizable y fibra de poliéster con tejido hidrófugo.  
Tapicería de tejido técnico para exterior desenfundable.



DNA José A. Gandía-Blasco Canales

CHAISE LOUNGE. TUMBONA



Thermo-lacquered aluminium. Polyurethane foam rubber covered with water-repellent fabric.  
Aluminio termolacado. Gomaespuma de poliuretano recubierta con tejido hidrófugo.

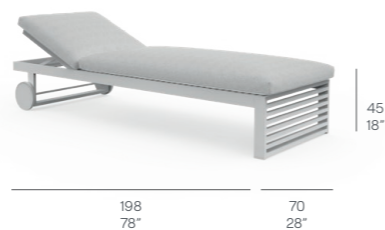

TIMELESS José A. Gandía-Blasco Canales. Borja García

SIDE TABLE. MESA TUMBONA



Powder-coated aluminium. Porcelain. Phenolic plate.  
Aluminio termolacado. Porcelánico. Tablero fenólico.



STACK Borja García

SIDE TABLE. MESA TUMBONA



Powder-coated aluminium. Phenolic plate. Stackable.  
Aluminio soldado termolacado. Tablero fenólico. Apilable.



DNA José A. Gandia-Blasco Canales

SIDE TABLE. MESA TUMBONA

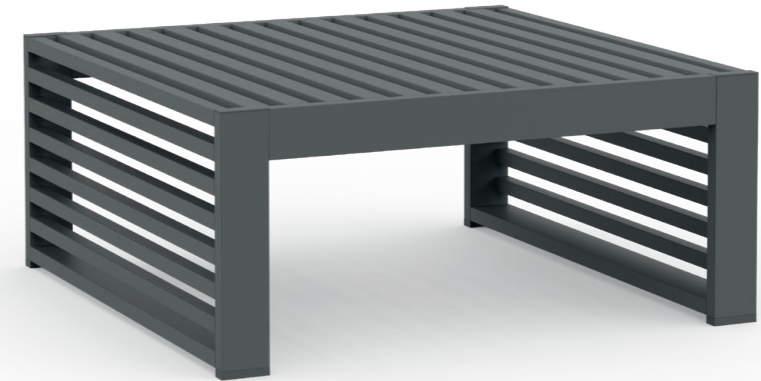

Powder-coated aluminium.  
Aluminio termolacado.

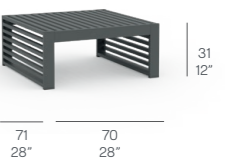

PICNIC José A. Gandía-Blasco Canales

DECKCHAIR. HAMACA



Thermo-lacquered aluminium. Self-supporting fabrics (Batyline®, Moaré and Grid).  
Aluminio termolacado. Telas autoportante (Batyline®, Moaré y Grid).



TRIP José A. Gandía-Blasco Canales / Borja García

DECKCHAIR. HAMACA



Textured powder-coated aluminium. Self-supporting fabrics (Batyline®, Moaré and Grid). Foldable. 4 positions. Adjustable lock to fix positions.  
Aluminio termolacado texturizado. Telas autoportante (Batyline®, Moaré y Grid). Plegable. 4 posiciones. Con seguro para fijar las posiciones.



DECKCHAIR SEXY. HAMACA SEXY

DECKCHAIR. HAMACA



Rotomoulded 100% recyclable polyethylene. Textured lacquered. Powder-coated stainless steel legs. Mat made from Gravidry® quick-dry and reusable polyurethane foam. Removable technical upholstery for outdoor use. NOTE. Mattresses meet CAL 117 regulations. Polyethylene+LED includes one LED module + remote control. Optional Led.

Poliétileno 100 % reciclable mediante moldeo rotacional. Lacado texturizado. Patas de acero inoxidable termolacado. Colchoneta de espuma de poliuretano reutilizable de secado rápido Gravidry®. Tapicería de tejido técnico para exterior desenfundable. NOTA. Las colchonetas cumplen la normativa CAL 117. Polyethylene+LED incluye un módulo LED + mando a distancia. Led Opcional.

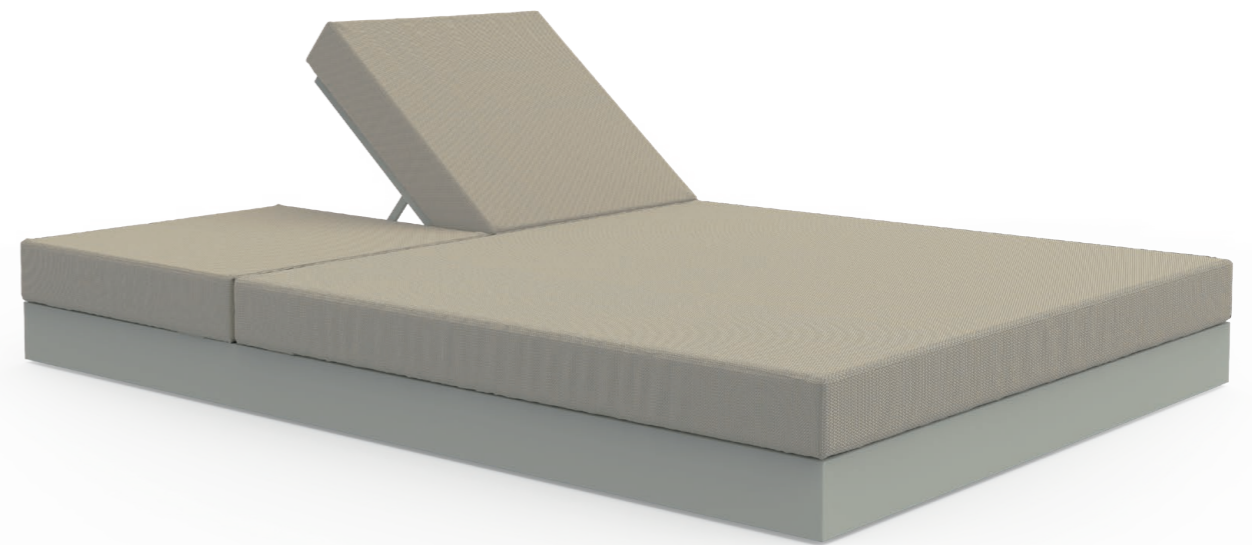
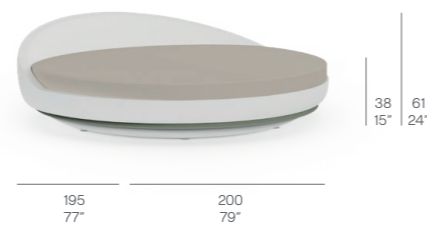

Thermo-lacquered aluminium. Polyurethane foam rubber covered with water-repellent fabric. Aluminio termolacado. Gomaespuma de poliuretano recubierta con tejido hidrófugo.

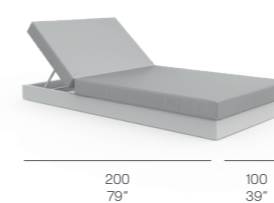

BED CAMA 100

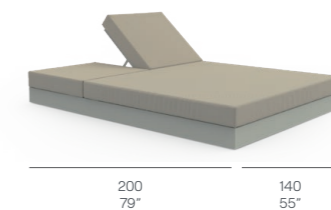

BED CAMA 140

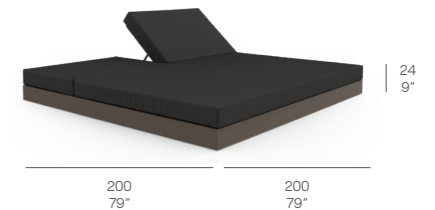

BED CAMA 200

DAYBED José A. Gandía-Blasco Canales

ELEVATED RECLINING DAYBED  
DAYBED ELEVADA RECLINABLE



Aluminium thermo-lacquered. Canopy of plastic fabric. Curtain fabric 100% acrylic.  
Aluminio termolacado. Lonas de tela plástica. Tejido cortina 100% acrílico.



PERGOLA VIP José A. Gandía-Blasco Canales



Aluminium thermo-lacquered. Canopy of plastic fabric. Phenolic.  
Aluminio termolacado. Lonas de tela plástica. Fenólico.



BASIC PERGOLAS José A. Gandía-Blasco Canales



BASIC PERGOLAS José A. Gandía-Blasco Canales

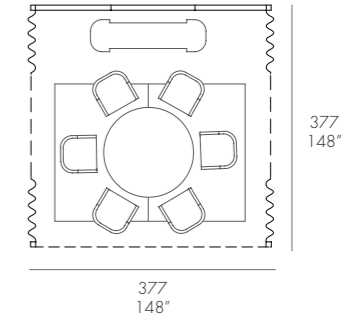

MODULE 1 377X377. MÓDULO 1 377X377

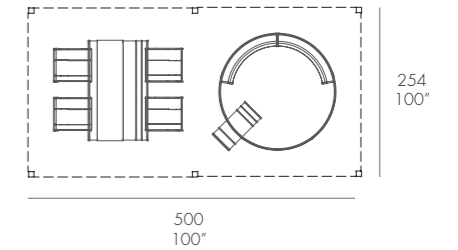

MODULE 2 254X500. MÓDULO 2 254X500

Powder-coated aluminum. Faux wood aluminum used only in the blades. Aluminum Deployé sidewall. 100% recyclable polyethylene. Soltis plastic fabric tarps. 100% acrylic curtain fabrics. 100% polypropylene webbing. Veta flooring. Vinyl chalkboard. Upholstered wall available in Soft Panama, Natté and Solids fabrics.  
 Aluminio termolacado. Aluminio madera utilizado solo en las lamas. Cerramiento Deployé de aluminio. Polietileno 100 % reciclable. Lonas de tela plástica Soltis. Tejido cortina 100 % acrílico. Cinchas de polipropileno 100%. Suelo de Veta. Pizarra de vinilo. Pared tapizada disponible en telas de Soft Panama, Natté y Solids.

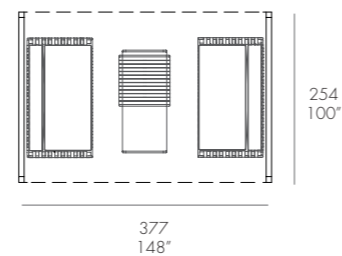

MODULE 1 254X377. MÓDULO 1 254X377

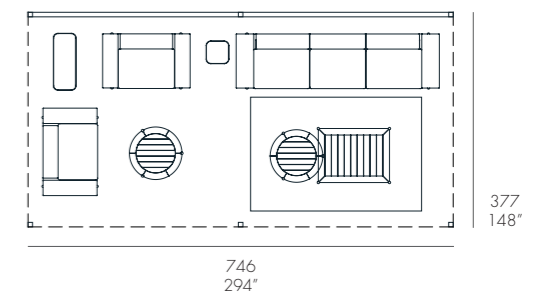

MODULE 2 377X746. MÓDULO 2.3 77X746

SOFA  
SOFA

LOUNGE CHAIR  
SILLÓN

SECTIONAL  
MODULAR

CLUB ARMCHAIRS  
BUTACAS

COFFEE TABLE  
MESA BAJA



## LACE Yonoh Studio

2 SEAT SOFA. SOFÁ 2 PLAZAS



Rotomoulded 100% recyclable polyethylene. Powder-coated stainless steel legs. Mat made from Gravidry® quick-dry and reusable polyurethane foam. Removable technical upholstery for outdoor use.  
 Polietileno 100 % reciclable mediante moldeo rotacional. Patas de acero inoxidable termolacado.  
 Colchoneta de espuma de poliuretano reutilizable de secado rápido Gravidry®. Tapicería de tejido técnico para exterior desenfundable.



## ARP Made Studio

2 SEAT SOFA. SOFÁ 2 PLAZAS



Made with a powder-coated aluminium structure. Polyurethane foam rubber covered with water-repellent fabric. Removable upholstery. Polyester fibre cushion.  
 Fabricado con estructura de aluminio termolacado texturizado. Gomaespuma de poliuretano recubierta con tejido hidrófugo. Tapicería desenfundable. Cojín de fibra de poliéster.



## XALOC Héctor Serrano

2 SEAT COMPACT SOFA - SOFÁ 2 PLAZAS COMPACT



Powder-coated aluminium. Tabletop is available in porcelain or phenolic plate. Mat and cushion made from Gravidry® quick-dry and reusable polyurethane foam. Removable technical upholstery for outdoor use. NOTE. Mattresses meet CAL 117 regulations.

Aluminio termolacado. Sobre de la mesa disponible en porcelánico o fenólico. Colchoneta y cojín de espuma de poliuretano reutilizable de secado rápido Gravidry®. Tapicería de tejido técnico para exterior desenfundable. NOTA. Las colchonetas cumplen la normativa CAL 117.



## XALOC Héctor Serrano

3 SEAT SOFA - SOFÁ 3 PLAZAS



Powder-coated aluminium. Tabletop is available in porcelain or phenolic plate. Mat and cushion made from Gravidry® quick-dry and reusable polyurethane foam. Removable technical upholstery for outdoor use. NOTE. Mattresses meet CAL 117 regulations.

Aluminio termolacado. Sobre de la mesa disponible en porcelánico o fenólico. Colchoneta y cojín de espuma de poliuretano reutilizable de secado rápido Gravidry®. Tapicería de tejido técnico para exterior desenfundable. NOTA. Las colchonetas cumplen la normativa CAL 117.



## RIBBONS Bandada Studio

2 SEAT SOFA. SOFÁ 2 PLAZAS



Powder-coated aluminium. 100% polypropylene webbing. Mat and cushion made from Gravidry® quick-dry and reusable polyurethane foam. Removable technical upholstery for outdoor use.

NOTE. Mattresses meet CAL 117 regulations.

Aluminio termolacado. Cinchas 100 % polipropileno. Colchoneta y cojín de espuma de poliuretano reutilizable de secado rápido Gravidry®. Tapicería de tejido técnico para exterior desenfundable.

NOTA. Las colchonetas cumplen la normativa CAL 117.



## COVER Bandada Studio

2 SEAT SOFA. SOFÁ 2 PLAZAS



Powder-coated aluminium. The covers are available in all upholstery fabrics. Mat and cushion made from Gravidry® quick-dry and reusable polyurethane foam. Removable technical upholstery for outdoor use.

NOTE. Mattresses meet CAL 117 regulations.

Aluminio termolacado. Las fundas están disponibles en todas las telas de tapicería. Colchoneta y cojín de espuma de poliuretano reutilizable de secado rápido Gravidry®. Tapicería de tejido técnico para exterior desenfundable. NOTA. Las colchonetas cumplen la normativa CAL 117.



## TIMELESS José A. Gandía-Blasco. Borja García

2 SEAT SOFA. SOFÁ 2 PLAZAS



Powder-coated aluminium. Teak wood. Seat in reusable polyurethane foam rubber and polyester fibre with water-repellent fabric. Backrest and cushion filled with polyester fibre with water-repellent fabric. Removable technical upholstery for outdoor use.  
 Aluminio soldado termolacado. Madera de teca. Asiento de gomaespuma de poliuretano reutilizable y fibra de poliéster con tejido hidrófugo. Respaldo y cojín relleno de fibra de poliéster con tejido hidrófugo. Tapicería de tejido técnico para exterior desenfundable.



## TIMELESS José A. Gandía-Blasco. Borja García

SECTIONAL 1. MODULAR 1



Powder-coated aluminium. Teak wood. Seat in reusable polyurethane foam rubber and polyester fibre with water-repellent fabric. Backrest and cushion filled with polyester fibre with water-repellent fabric. Removable technical upholstery for outdoor use.  
 Aluminio soldado termolacado. Madera de teca. Asiento de gomaespuma de poliuretano reutilizable y fibra de poliéster con tejido hidrófugo. Respaldo y cojín relleno de fibra de poliéster con tejido hidrófugo. Tapicería de tejido técnico para exterior desenfundable.

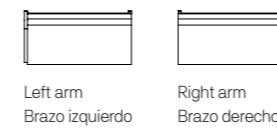

## TIMELESS José A. Gandía-Blasco. Borja García

SECTIONAL 2. MODULAR 2



Powder-coated aluminium. Teak wood. Seat in reusable polyurethane foam rubber and polyester fibre with water-repellent fabric. Backrest and cushion filled with polyester fibre with water-repellent fabric. Removable technical upholstery for outdoor use.

Aluminio soldado termolacado. Madera de teca. Asiento de gomaespuma de poliuretano reutilizable y fibra de poliéster con tejido hidrófugo. Respaldo y cojín relleno de fibra de poliéster con tejido hidrófugo. Tapicería de tejido técnico para exterior desenfundable.



Left arm  
Brazo izquierdo



Right arm  
Brazo derecho



## TIMELESS José A. Gandía-Blasco. Borja García

SECTIONAL 3. MODULAR 3



Powder-coated aluminium. Teak wood. Seat in reusable polyurethane foam rubber and polyester fibre with water-repellent fabric. Backrest and cushion filled with polyester fibre with water-repellent fabric. Removable technical upholstery for outdoor use.

Aluminio soldado termolacado. Madera de teca. Asiento de gomaespuma de poliuretano reutilizable y fibra de poliéster con tejido hidrófugo. Respaldo y cojín relleno de fibra de poliéster con tejido hidrófugo. Tapicería de tejido técnico para exterior desenfundable.



## TIMELESS José A. Gandía-Blasco. Borja García

SECTIONAL 4. MODULAR 4



Powder-coated aluminium. Teak wood. Seat in reusable polyurethane foam rubber and polyester fibre with water-repellent fabric. Backrest and cushion filled with polyester fibre with water-repellent fabric. Removable technical upholstery for outdoor use.

Aluminio soldado termolacado. Madera de teca. Asiento de gomaespuma de poliuretano reutilizable y fibra de poliéster con tejido hidrófugo. Respaldo y cojín relleno de fibra de poliéster con tejido hidrófugo. Tapicería de tejido técnico para exterior desenfundable.



## LIPSTICK José A. Gandía-Blasco Canales

CLUB ARMCHAIR. BUTACA



Made of rotomoulded 100% recyclable polyethylene.

Fabricado en polietileno 100 % reciclable mediante moldeo rotacional.

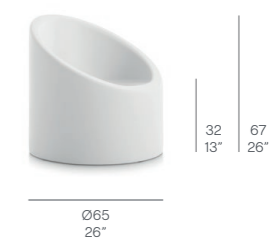

356 José A. Gandía-Blasco Canales. Pablo Gironés

CLUB CHAIR. BUTACA



Made of rotomoulded 100% recyclable polyethylene. Fabricado en polietileno 100 % reciclable mediante moldeo rotacional.

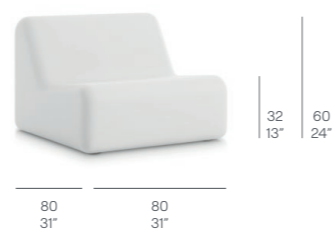

STACK Borja García

DINING CLUB ARMCHAIR. BUTACA



Powder-coated aluminium. Self-supporting fabrics (Batylene®, Moaré and Grid). Stackable. Aluminio termolacado. Telas autoportante (Batylene®, Moaré y Grid). Apilable.



LACE Yonoh Studio

CLUB CHAIR. BUTACA



Rotomoulded 100% recyclable polyethylene. Powder-coated stainless steel legs. Mat made from Gravidry® quick-dry and reusable polyurethane foam. Removable technical upholstery for outdoor use.  
 Polietileno 100 % reciclable mediante moldeo rotacional. Patas de acero inoxidable termolacado.  
 Colchoneta de espuma de poliuretano reutilizable de secado rápido Gravidry®. Tapicería de tejido técnico para exterior desenfundable.



ARP Made Studio

LOUNGE CHAIR. SILLÓN



Made with a powder-coated aluminium structure. Polyurethane foam rubber covered with water-repellent fabric. Removable upholstery. Polyester fibre cushion.  
 Fabricado con estructura de aluminio termolacado texturizado. Gomaespuma de poliuretano recubierta con tejido hidrófugo. Tapicería desenfundable. Cojín de fibra de poliéster.

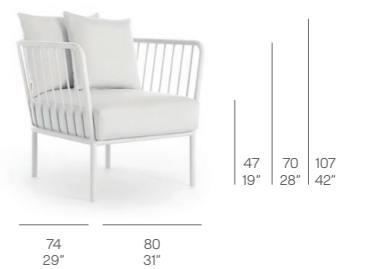

XALOC Héctor Serrano

CLUB CHAIR. BUTACA



Powder-coated aluminium. Mat and cushion made from Gravidry® quick-dry and reusable polyurethane foam. Removable technical upholstery for outdoor use. NOTE. Mattresses meet CAL 117 regulations.  
Aluminio termolacado. Colchoneta y cojín de espuma de poliuretano reutilizable de secado rápido Gravidry®. Tapicería de tejido técnico para exterior desenfundable. NOTA. Las colchonetas cumplen la normativa CAL 117.



RIBBONS Bandada Studio

LOUNGE CHAIR. SILLÓN



Powder-coated aluminium. 100% polypropylene webbing. Mat and cushion made from Gravidry® quick-dry and reusable polyurethane foam. Removable technical upholstery for outdoor use. NOTE. Mattresses meet CAL 117 regulations.  
Aluminio termolacado. Cinchas 100 % polipropileno. Colchoneta y cojín de espuma de poliuretano reutilizable de secado rápido Gravidry®. Tapicería de tejido técnico para exterior desenfundable. NOTA. Las colchonetas cumplen la normativa CAL 117.

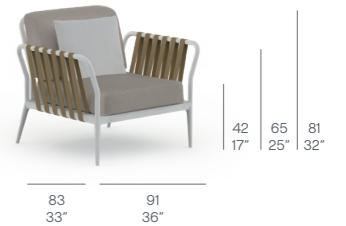

COVER Bandada Studio

CLUB CHAIR. BUTACA



Powder-coated aluminium. The covers are available in all upholstery fabrics. Mat and cushion made from Gravidry® quick-dry and reusable polyurethane foam. Removable technical upholstery for outdoor use.

NOTE. Mattresses meet CAL 117 regulations.

Aluminio termolacado. Las fundas están disponibles en todas las telas de tapicería. Colchoneta y cojín de espuma de poliuretano reutilizable de secado rápido Gravidry®. Tapicería de tejido técnico para exterior desenfundable.

NOTA. Las colchonetas cumplen la normativa CAL 117.



TIMELESS José A. Gandía-Blasco. Borja García

LOUNGE CHAIR. SILLÓN



Powder-coated aluminium. Teak wood. Seat in reusable polyurethane foam rubber and polyester fibre with water-repellent fabric. Backrest and cushion filled with polyester fibre with water-repellent fabric. Removable technical upholstery for outdoor use.

Aluminio soldado termolacado. Madera de teca. Asiento de gomaespuma de poliuretano reutilizable y fibra de poliéster con tejido hidrófugo. Respaldo y cojín relleno de fibra de poliéster con tejido hidrófugo. Tapicería de tejido técnico para exterior desenfundable.



NEXO Bandada Studio

CLUB CHAIR. BUTACA



Powder-coated aluminium. The covers are available in all upholstery fabrics. Mat and cushion made from Gravidry® quick-dry and reusable polyurethane foam. Removable technical upholstery for outdoor use.  
 Aluminio termolacado. Las fundas están disponibles en todas las telas de tapicería. Colchoneta y cojín de espuma de poliuretano reutilizable de secado rápido Gravidry®. Tapicería de tejido técnico para exterior desenfundable.



LOUNGE CHAIR+ C TABLE. SILLÓN + MESA AUXILIAR



85 93  
34" 37"  
42 66 80  
16" 26" 31"

LIPSTICK José A. Gandía-Blasco Canales

COFFEE TABLE. MESA BUTACA



Made of rotomoulded 100% recyclable polyethylene.  
 Fabricado en polietileno 100 % reciclable mediante moldeo rotacional.



Ø65  
26"

32  
13"

356 José A. Gandía-Blasco Canales. Pablo Gironés

COFFEE TABLE. MESA BUTACA



Made of rotomoulded 100% recyclable polyethylene.  
Fabricado en polietileno 100 % reciclable mediante moldeo rotacional.

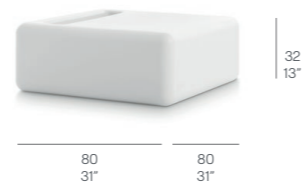

LACE Yonoh Studio

COFFEE TABLE. MESA BAJA



Rotomoulded 100% recyclable polyethylene. Powder-coated stainless steel legs.  
Polietileno 100 % reciclable mediante moldeo rotacional. Patas de acero inoxidable termolacado.



HARBOR Archirivolto

COFFEE TABLE. MESA BAJA



Powder-coated aluminium. Tabletop is available in porcelain and phenolic plate.  
Aluminio termolacado. Sobre de la mesa disponible en porcelánico y fenólico.

Fixed. Fija  
Collapsible. Plegable



HARBOR XL Archirivolto

COFFEE TABLE. MESA BAJA



Powder-coated aluminium. Tabletop is available in porcelain and phenolic plate.  
Aluminio termolacado. Sobre de la mesa disponible en porcelánico y fenólico.

Fixed. Fija

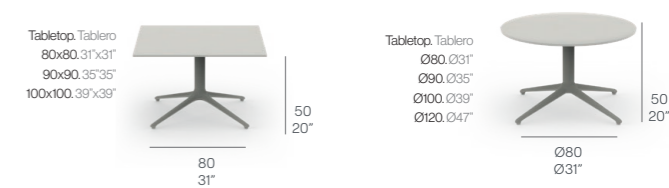



Made with a powder-coated aluminium structure. Phenolic plate.  
 Fabricado con estructura de aluminio termolacado texturizado. Sobre de la mesa de fenólico.



Powder-coated aluminium. Porcelain. Phenolic plate.  
 Aluminio termolacado. Porcelánico. Tablero fenólico.



ARAM Nendo

LOW COFFEE TABLE. MESA BAJA

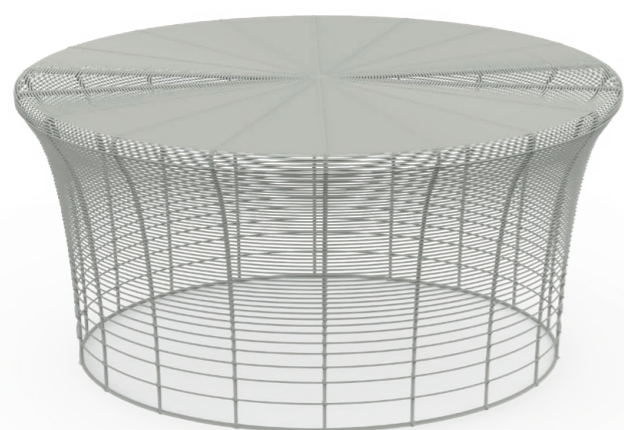

Made of thermo-lacquered stainless steel wire. Handmade. Because they are made entirely by hand, all these items are unique.

Alambre de acero inoxidable termolacado. Hechas a mano. Cada una de estas piezas es única debido a su proceso de fabricación totalmente manual.



DNA José A. Gandia-Blasco Canales

COFFEE TABLE. MESA BAJA



Powder-coated aluminium.

Aluminio termolacado.

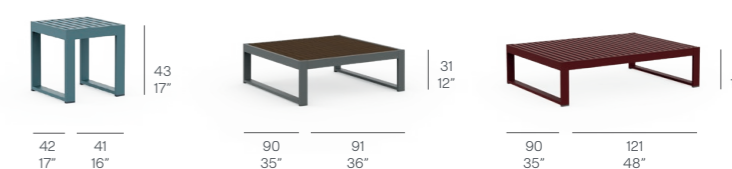

MESA 01

COFFEE TABLE. MESA BAJA



Powder-coated aluminium. Phenolic plate. Porcelain.  
Aluminio soldado termolacado. Tablero fenólico. Porcelánico.

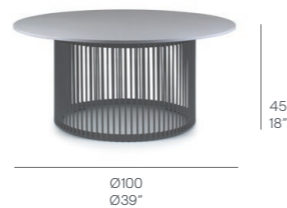

MESA 03

COFFEE TABLE. MESA BAJA



Powder-coated aluminium. Phenolic plate. Porcelain.  
Aluminio soldado termolacado. Tablero fenólico. Porcelánico.



DINING CHAIR  
SILLA

STOOL  
TABURETE

TABLE  
MESA

BAR TABLE  
MESA BAR



CLASSE Yonoh Studio

SLATS DINING CHAIR. SILLA



Fiberglass-reinforced polypropylene resin chairs. Mat made from Gravidry® quick-dry and reusable polyurethane foam. Removable technical upholstery for outdoor use. Stackable.  
Sillas de resina de polipropileno reforzada con fibra de vidrio. Colchonetas de espuma de poliuretano reutilizable de secado rápido Gravidry®. Tapicería de tejido técnico para exterior desenfundable. Apilable.



EASY Rocío Gambín

DINING CHAIR. SILLA



Textured powder-coated aluminium structure. Stackable.  
Estructura de aluminio termolacado texturizado.. Apilable.

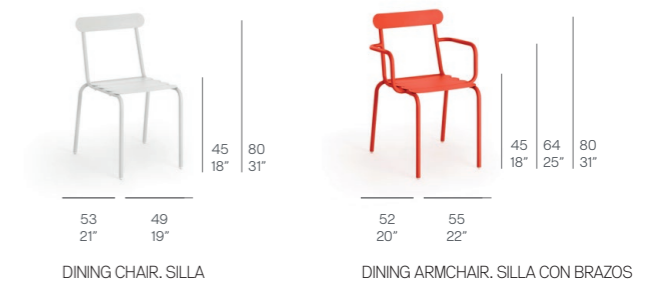

CLACK! José A. Gandía-Blasco Canales

FOLDING CHAIR. SILLA



Thermo-lacquered aluminium. Self-supporting fabrics (Batyline®, Moaré and Grid). Folding.  
 Aluminio termolacado. Telas autoportante (Batyline®, Moaré y Grid). Plegable.



VENT Made Studio

DINING CHAIR MODEL 1. SILLA MODELO 1



Made of thermo-lacquered galvanized steel and stiff lacquered polyurethane.  
 Fabricado con acero zincado termolacado y poliuretano rígido lacado.

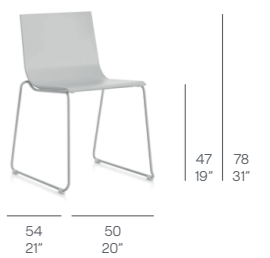

STACK Borja García

DINING ARMCHAIR. SILLA CON BRAZOS



Powder-coated aluminium. Batyline® fabric. Stackable.  
Aluminio soldado termolacado. Tela Batyline®. Apilable.



PLIER OiKo Design

DINING CHAIR. SILLA



Textured powder-coated aluminium structure. Stackable.  
Estructura de aluminio termolacado texturizado.. Apilable.



ESPAGUETI ERRE

DINING CHAIR. SILLA SIN TAPIZADO



Textured powder-coated galvanized steel rod. Textured Powder-coated aluminium frame. Upholstered option with quick-drying Gravidry® polyurethane foam and outdoor technical fabric.  
 Varilla de acero zincado termolacado texturizado. Carcasa de aluminio termolacado texturizado. Opción tapizada con espuma de poliuretano de secado rápido Gravidry® y tapicería de tejido técnico para exterior.

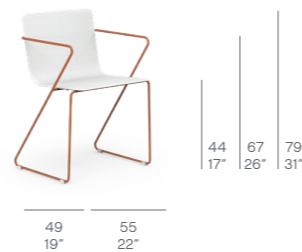

TRIP José A. Gandía-Blasco Canales / Borja García

DIRECTOR ARMCHAIR. SILLA DIRECTOR



Textured powder-coated galvanized steel rod. Textured Powder-coated aluminium frame. Upholstered option with quick-drying Gravidry® polyurethane foam and outdoor technical fabric.  
 Varilla de acero zincado termolacado texturizado. Carcasa de aluminio termolacado texturizado. Opción tapizada con espuma de poliuretano de secado rápido Gravidry® y tapicería de tejido técnico para exterior.



RIBBONS Bandada Studio

DINING ARMCHAIR. SILLA CON BRAZOS



Powder-coated aluminium. 100% polypropylene webbing. Mat and cushion made from Gravidry® quick-dry and reusable polyurethane foam. Removable technical upholstery for outdoor use.  
 Aluminio termolacado. Cinchas 100 % polipropileno. Colchoneta y cojín de espuma de poliuretano reutilizable de secado rápido Gravidry®. Tapicería de tejido técnico para exterior desenfundable.

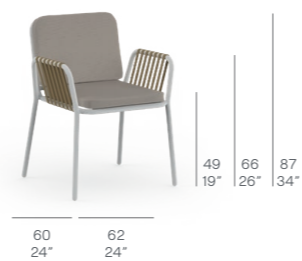

COVER Bandada Studio

DINING ARMCHAIR. SILLA CON BRAZOS



Powder-coated aluminium. The covers are available in all upholstery fabrics. Made from Gravidry® quick-dry and reusable polyurethane foam. Removable technical upholstery for outdoor use.  
 Aluminio termolacado. Las fundas están disponibles en todas las telas de tapicería. Espuma de poliuretano reutilizable de secado rápido Gravidry®. Tapicería de tejido técnico para exterior desenfundable.

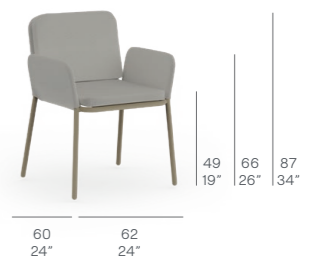

CORDA

DINING ARMCHAIR. SILLA CON BRAZOS



Powder-coated aluminium. Braided rope polypropylene. Reusable polyurethane foam rubber covered with water-repellent fabric.  
 Aluminio soldado termolacado. Cuerda de polipropileno trenzado. Gomaespuma de poliuretano reutilizable recubierta con tejido hidrófugo.



FLAT TEXTIL Mario Ruiz

DINING CHAIR. SILLA



Powder-coated aluminium. Self-supporting fabrics (Batyline®, Moaré and Grid).  
 Aluminio termolacado. Telas autoportante (Batyline®, Moaré y Grid).

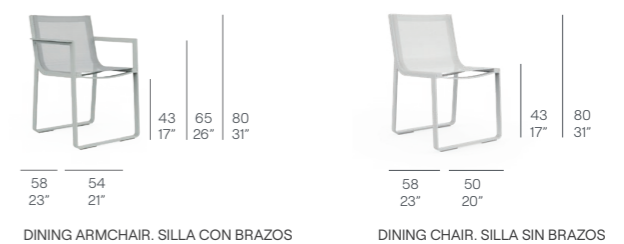

TIMELESS José A. Gandía-Blasco Canales. Borja García

DINING ARMCHAIR. SILLA CON BRAZOS



Powder-coated aluminium. Teak wood. Polyurethane foam rubber covered with water-repellent fabric.  
Aluminio soldado termolacado. Madera de teca. Gomaespuma de poliuretano recubierta con tejido hidrófugo.



FLAT Mario Ruiz

DINING CHAIR. SILLA



Powder-coated aluminium. 100% recyclable polyethylene. Polyurethane foam rubber covered with water-repellent fabric.  
Aluminio soldado termolacado. Polietileno 100% reciclable. Gomaespuma de poliuretano recubierta con tejido hidrófugo.



## CLASSE Yonoh Studio

SLATS STOOL 30". TABURETE SLATS 76



Fiberglass-reinforced polypropylene resin chairs. Mat made from Gravidry® quick-dry and reusable polyurethane foam. Removable technical upholstery for outdoor use. Stackable.

Sillas de resina de polipropileno reforzada con fibra de vidrio. Colchonetas de espuma de poliuretano reutilizable de secado rápido Gravidry®. Tapicería de tejido técnico para exterior desenfundable. Apilable.



## AIR Héctor Serrano

STOOL TABURETE



Rotomoulded 100 % recyclable polyethylene.

Polietileno 100 % reciclable mediante moldeo rotacional.



LACE Yonoh Studio

STOOL TABURETE



Rotomoulded 100% recyclable polyethylene. Powder-coated stainless steel legs.  
Polietileno 100 % reciclable mediante moldeo rotacional. Patas de acero inoxidable termolacado.



VENT Made Studio

HIGH STOOL MODEL 1 - TABURETE ALTO MODELO 1



Made of thermo-lacquered galvanized steel and stiff lacquered polyurethane.  
Fabricado con acero zincado termolacado y poliuretano rígido lacado.



STACK Borja García

HIGH STOOL. TABURETE ALTO

HARBOR Archirivolto

DINING TABLE. MESA ALTA



Powder-coated aluminium. Phenolic plate.  
Aluminio soldado termolacado. Tablero fenólico.

Powder-coated aluminium. Tabletop is available in porcelain and phenolic plate.  
Aluminio termolacado. Sobre de la mesa disponible en porcelánico y fenólico.

Fixed. Fija  
Collapsible. Plegable



HARBOR XL Archirivolto

DINING TABLE. MESA ALTA



Powder-coated aluminium. Tabletop is available in porcelain and phenolic plate.  
Aluminio termolacado. Sobre de la mesa disponible en porcelánico y fenólico.

Fixed. Fija



MONA Diabla team

D80 DINING TABLE. MESA ALTA D80



Textured powder-coated aluminium and powder-coated zinc-plated steel bases.  
Aluminio termolacado texturizado y bases de acero zincado termolacado texturizado.

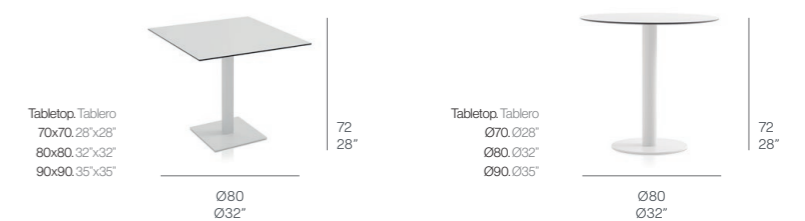

STACK Borja García

DINING TABLE. MESA ALTA



Powder-coated aluminium. Phenolic plate.  
Aluminio soldado termolacado. Tablero fenólico.



TIMELESS José A. Gandía-Blasco Canales. Borja García

DINING TABLE. MESA ALTA



Powder-coated aluminium. Porcelain. Phenolic plate.  
Aluminio termolacado. Porcelánico. Tablero fenólico.



FLAT Mario Ruiz

DINING TABLE. MESA ALTA

LACE Yonoh Studio

BAR TABLE. MESA BAR

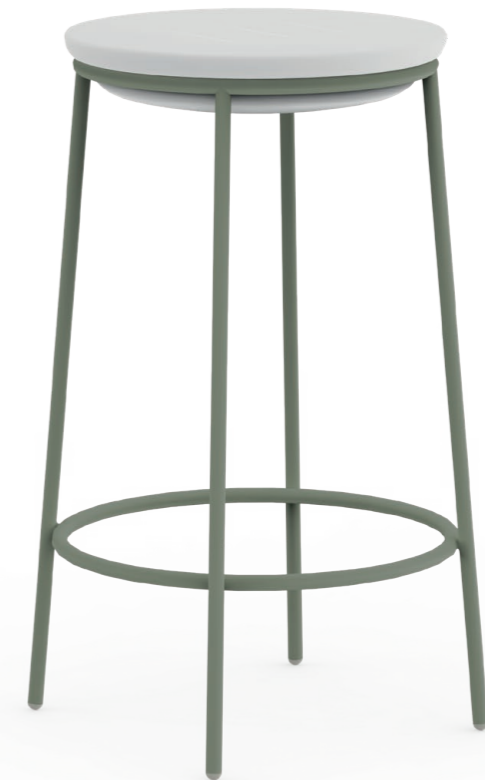

Powder-coated aluminium. 100% recyclable polyethylene. Porcelain.  
 Aluminio soldado termolacado. Polietileno 100% reciclable. Porcelánico.



Rotomoulded 100% recyclable polyethylene. Powder-coated stainless steel legs.  
 Polietileno 100 % reciclable mediante moldeo rotacional. Patas de acero inoxidable termolacado.



HARBOR Archirivolto

BAR TABLE. MESA BAR

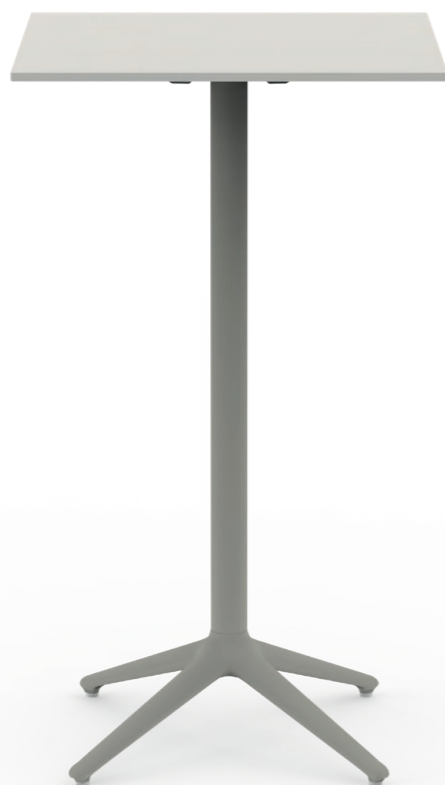

Powder-coated aluminium. Tabletop is available in porcelain and phenolic plate.  
Aluminio termolacado. Sobre de la mesa disponible en porcelánico y fenólico.

Fixed. Fija  
Collapsible. Plegable



HARBOR XL Archirivolto

BAR TABLE. MESA BAR



Powder-coated aluminium. Tabletop is available in porcelain and phenolic plate.  
Aluminio termolacado. Sobre de la mesa disponible en porcelánico y fenólico.

Fixed. Fija



STACK Borja García

BAR TABLE. MESA BAR



Powder-coated aluminium. Phenolic plate.  
Aluminio soldado termolacado. Tablero fenólico.



MONA Diabla team

BAR TABLE. MESA BAR



Made of thermo-lacquered galvanized steel and phenolic plate.  
Fabricado con acero zincado termolacado y tablero fenólico.

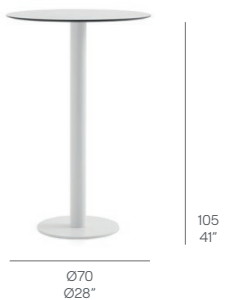

# ACCESSORIES

COMPLEMENTOS



ENSOMBRA Odosdesign

SOMBRILLA. FOLDING PARASOL



Folding parasol. Pole thermo-lacquered stainless steel. Phenolic plate strips. Galvanized thermo-lacquered steel base.  
Parasol plegable. Mástil de acero inoxidable termolacado. Lamas de tablero fenólico. Base de acero galvanizado termolacado.



Ø180  
Ø71"

212  
83"

BRISA

SOMBRILLA. FOLDING PARASOL



Folding umbrella. Powder-coated aluminum profiles. 100% solution dyed acrylic fabric. Water-resistant. Concrete base.  
Parasol plegable. Perfilera de aluminio termolacado. Tela 100% acrílica tintada en masa. Repelente al agua. Base de hormigón.



320  
126"

ROUND FOLDING PARASOL. SOMBRILLA CIRCULAR



230  
91"

SQUARE FOLDING PARASOL. SOMBRILLA CUADRADA

242  
95"

242  
95"

GOBI Pablo Gironés

PLANTER. MACETERO



Made of rotomoulded 100% recyclable polyethylene.  
Fabricado en polietileno 100 % reciclable mediante moldeo rotacional.



LACE Yonoh Studio

PLANTER. MACETERO



Rotomoulded 100% recyclable polyethylene. Powder-coated stainless steel legs.  
Polietileno 100 % reciclable mediante moldeo rotacional. Patas de acero inoxidable termolacado.



## SAIL Héctor Serrano

POUF SAIL. PUF SAIL



Removable technical upholstery for outdoor use. Filled with a combination of polystyrene pearls and chopped reusable polyurethane with a water-repellent textile cover. Available in all fabrics of the collection.

Tapicería de tejido técnico para exterior desenfundable. Relleno de mezcla de perlas poliestireno y picado de poliuretano con tejido hidrófugo. Disponible en todas las telas de la colección.

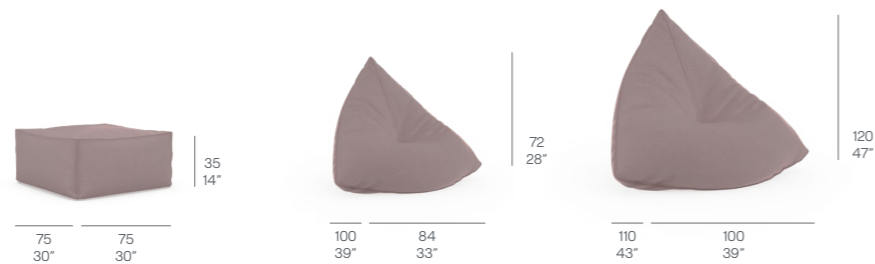

## PLISY Alejandra Gandía-Blasco

PORTABLE LAMP. LÁMPARA PORTÁTIL



Polyethelene shade. Braided rope polyester.

Pantalla de polietileno. Cuerda de poliéster trenzado.



# COLORS COLLECTION

COLORES COLECCIÓN



### FRAME. ESTRUCTURA



9016 White  
7038 Agate grey  
1019 Sand  
Gold  
1005 Honey  
7006 Bronze  
6013 Leaf  
7033 Cement Grey  
6007 Bottle Green



Cuprum  
3005 Wine Red  
7043 Anthracite  
5008 Grey Blue  
Night Blue  
9011 Black  
3015 Pink  
3020 Red  
**only for diabla**    **only for diabla**

### PORCELAIN. PORCELÁNICO



Zenith  
Aura  
Dance  
Pearl  
Argentum  
Akmola  
Charcoal Grey  
Black Marble  
Domoos

### PHENOLIC



White  
Folkestone  
Sand  
Bronze  
Burgundy  
Anthracite  
Black  
Bruno Marble



Pink  
Red  
**only for diabla**    **only for diabla**

Black core / Núcleo negro 

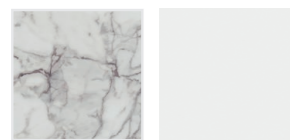

Albar Marble  
Full White

White core / Núcleo blanco 

### POLYPROPYLENE. POLIPROPILENO



White  
Sand  
Anthracite

### TEAK



Teak

### POLYETHYLENE



White  
Sand  
Anthracite  
Pink  
Red  
**only for diabla**    **only for diabla**

### ROPE. CUERDA

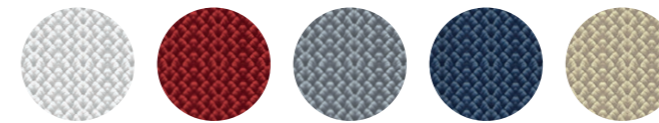

White  
Red  
Grey  
Navy  
Sand

### WEBBING. CINCHAS

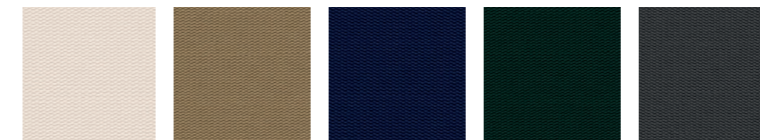

Ivory  
Sand  
Navy  
Dark Green  
Anthracite

### SUNBATHE FABRIC / TELA SUNBATHE

#### Batylite®



White  
Light grey  
Black  
Ivory  
Bronze  
Green  
Night blue

#### Moaré

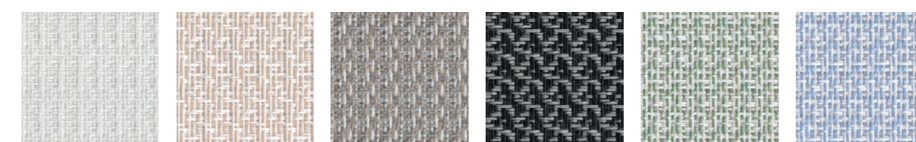

White  
Ivory  
Stone  
Black  
Light green  
Light blue

# OUTDOOR FABRICS COLLECTION. COLECCIÓN DE TELAS EXTERIOR

## NÁUTICA

### SILVERTEX ☉

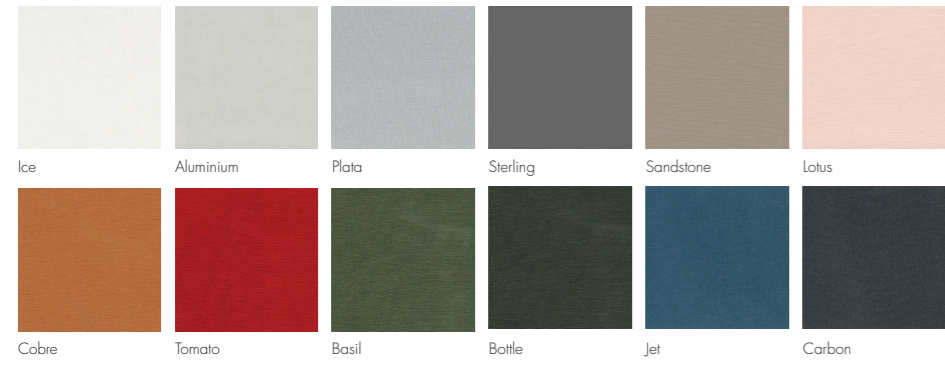

### GEMINI

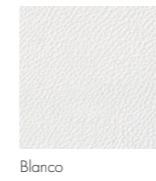

## SOFT

### GOFRE

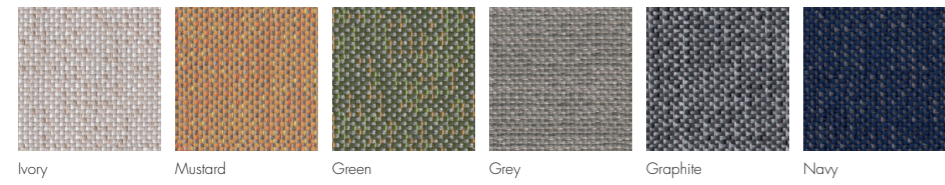

### PLAIN

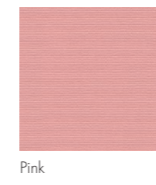

### SAINT-TROPEZ



### ESPIGA



### PANAMA

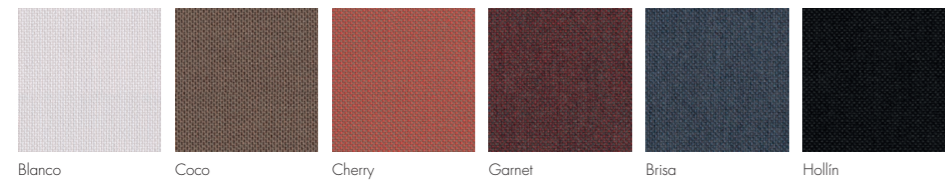

### NATTÉ

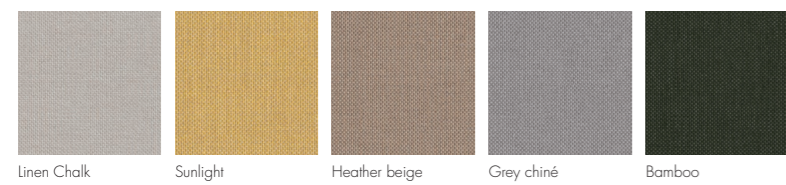

### SOLIDS

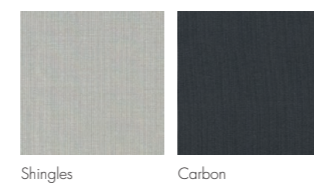

## WARM PREMIUM

### CHESTER



### LIBERA



## WARM

### MOARÉ

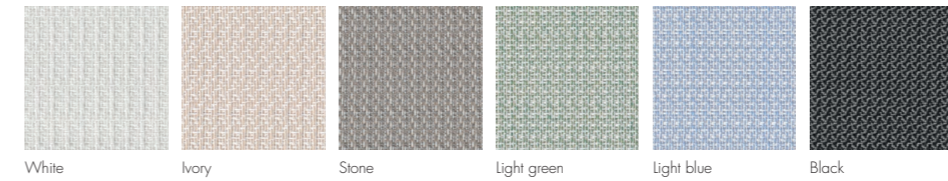

### LINO ☉



### TULUM

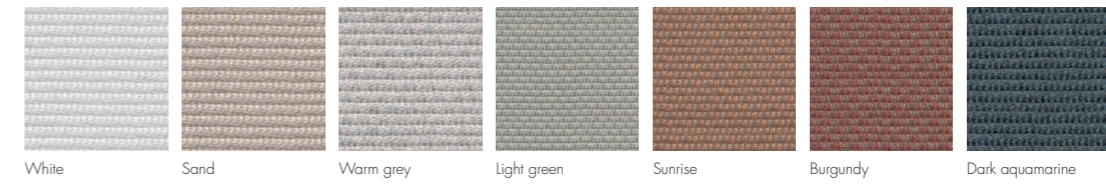

### MINOA

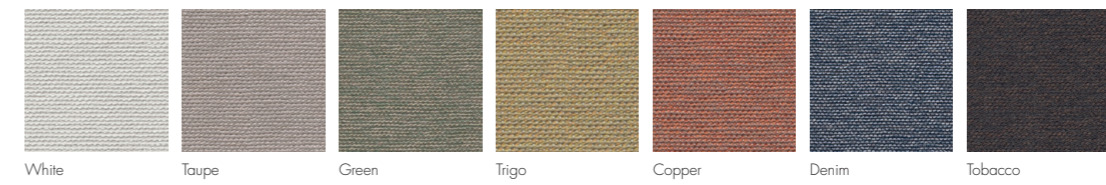

### PATIO ☉

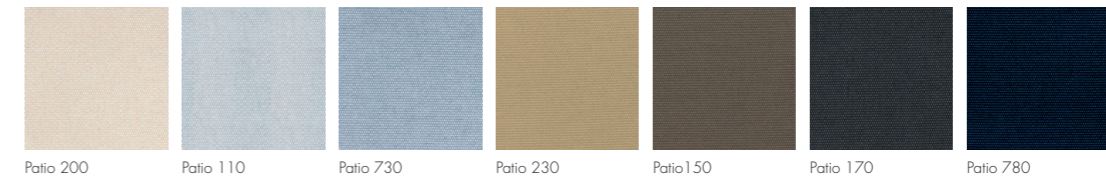

### BORA-BORA ☉



## WARM RECYCLED

### TRIBAL

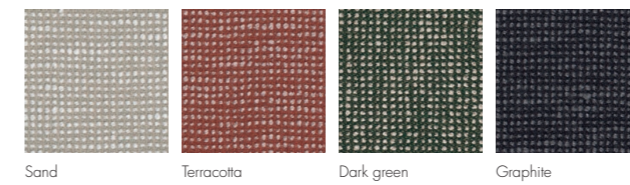

### AMELIA ☉

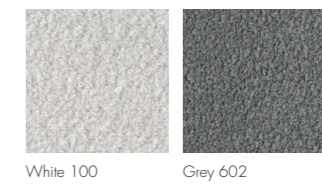

### IRIS ☉

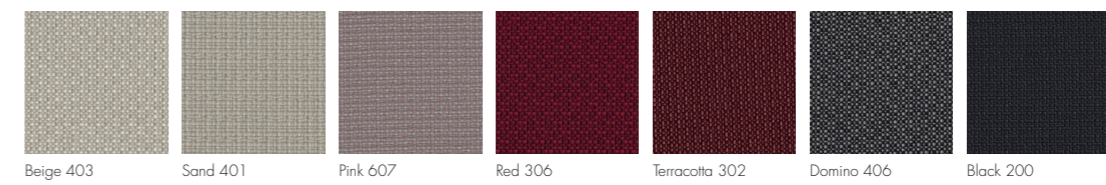

☉ Note. Highlighted textiles are available in BS 5852.  
Nota. Los textiles remarcados están disponibles en BS 5852.





G A N  
D I A  
B L A  
S C O

Gandia Blasco **Group**  
1941

GANDIABLASCO

[www.gandiablasco.com](http://www.gandiablasco.com)

diabla

[www.diablaoutdoor.com](http://www.diablaoutdoor.com)